



THIS IS / C'EST / QUESTO È / ESTA ES

SINGLE PADEL

1.

SET 6.9

COURT 6.3/8

TOPSPIN 5.2

BREAK 12

MATCH 3.5

BREAK 13

MATCH 4.2

BREAK 14

MATCH 4.4

BREAK 15

MATCH 5.2

LOB 4.16

MATCH 6.9

LOB 5.2

SMASH 4.4

LOB 6.9

SMASH 5.2



Iso 9001
Certificate



Product Brand
Certificate



UNE 1090
Certificate



PQT.
Certificate



SINGLE PADEL SET 6.9

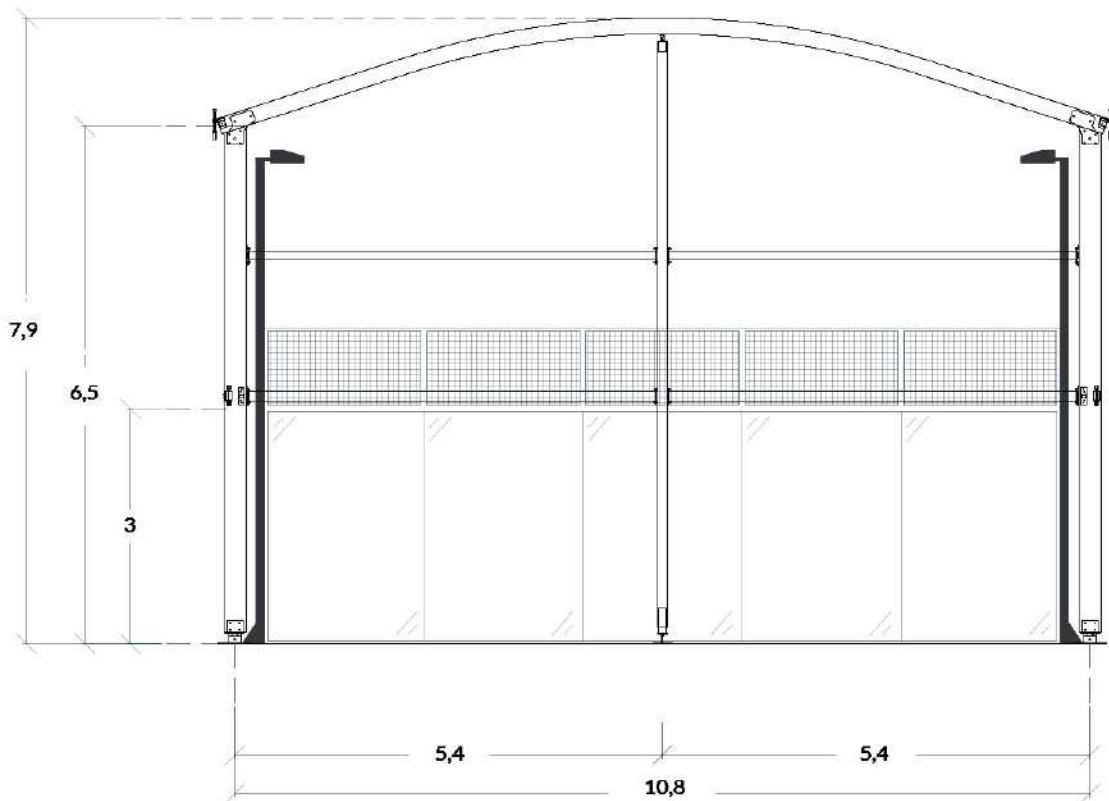

Courts number 1 / 2
Nombre de courts 1 / 2
Numero campi da gioco 1 / 2
Número de pistas 1 / 2



Fundations needed
Fondations nécessaires
Fondazioni necessarie
Cimentaciones necesarias



Medium snow loads
Charge de neige moyenne
Carico neve medio
Cargas de nieve media



Allows outside play
Permet le jeu extérieur
Permette il gioco all'esterno
Permite juego exterior

Side view | *Vue latérale* | *Vista laterale* | *Vista Lateral*

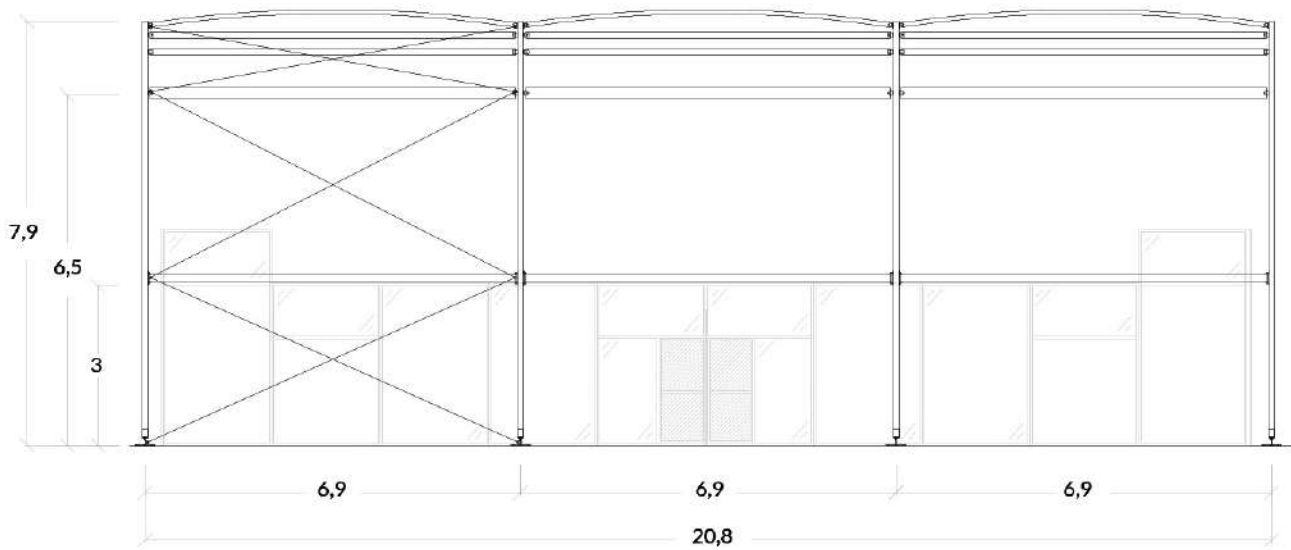

Top view | *Vue plan* | *Pianta* | *Planta*

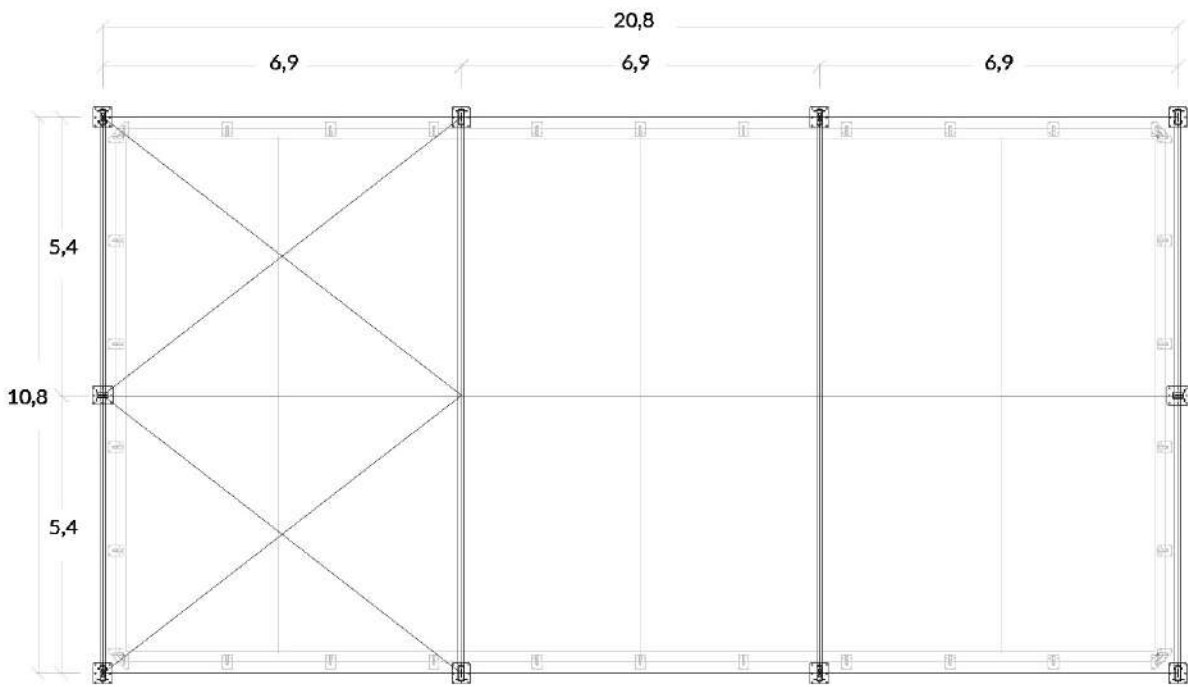

Top view double | *Vue plan double* | *Doppia pianta* | *Planta doble*

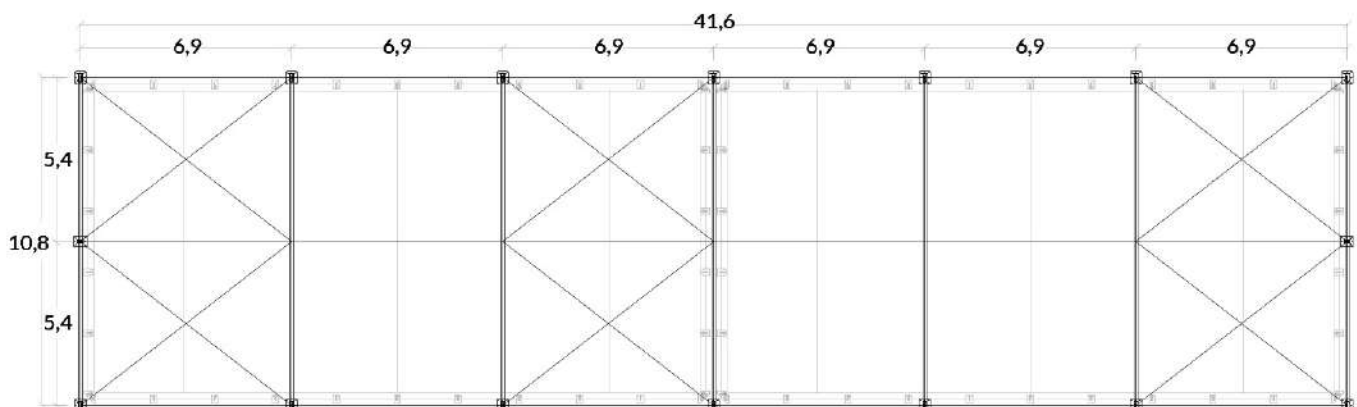



SINGLE PADEL TOPSPIN 5.2

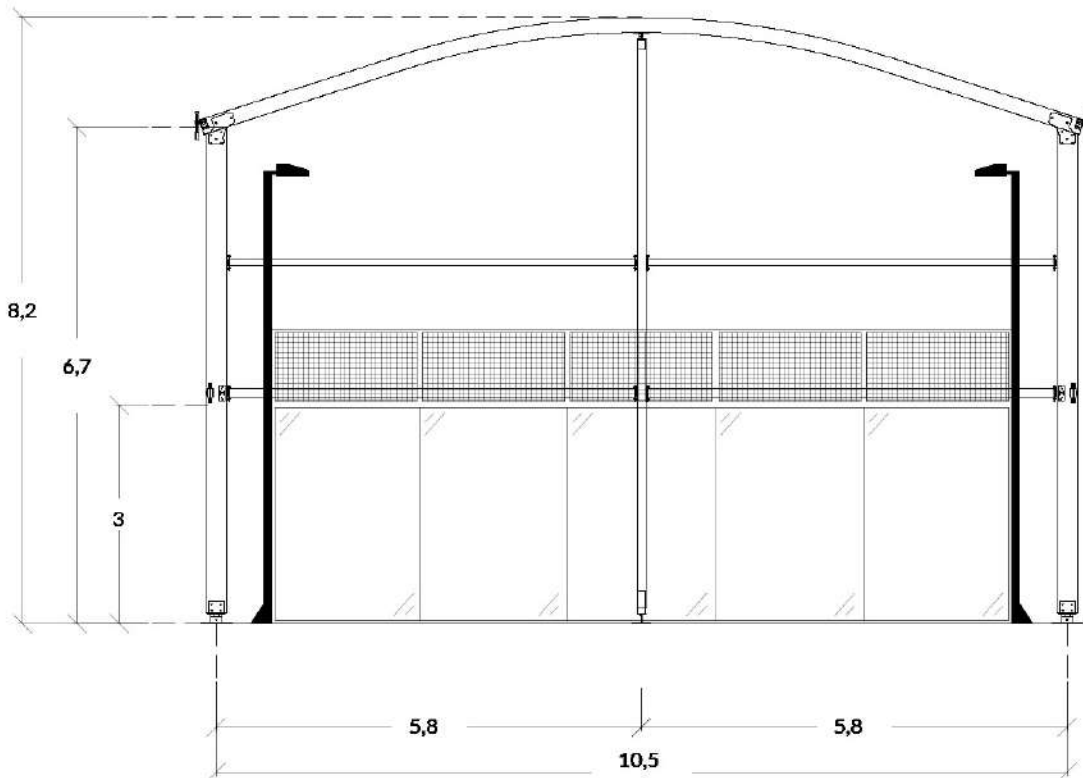

Courts number 1 / 2
Nombre de courts 1 / 2
Numero campi da gioco 1 / 2
Número de pistas 1 / 2



Fundations needed
Fondations nécessaires
Fondazioni necessarie
Cimentaciones necesarias



Medium snow loads
Charge de neige moyenne
Carico neve medio
Cargas de nieve media



Allows outside play
Permet le jeu extérieur
Permette il gioco all'esterno
Permite juego exterior

Side view | *Vue latérale* | *Vista laterale* | *Vista Lateral*

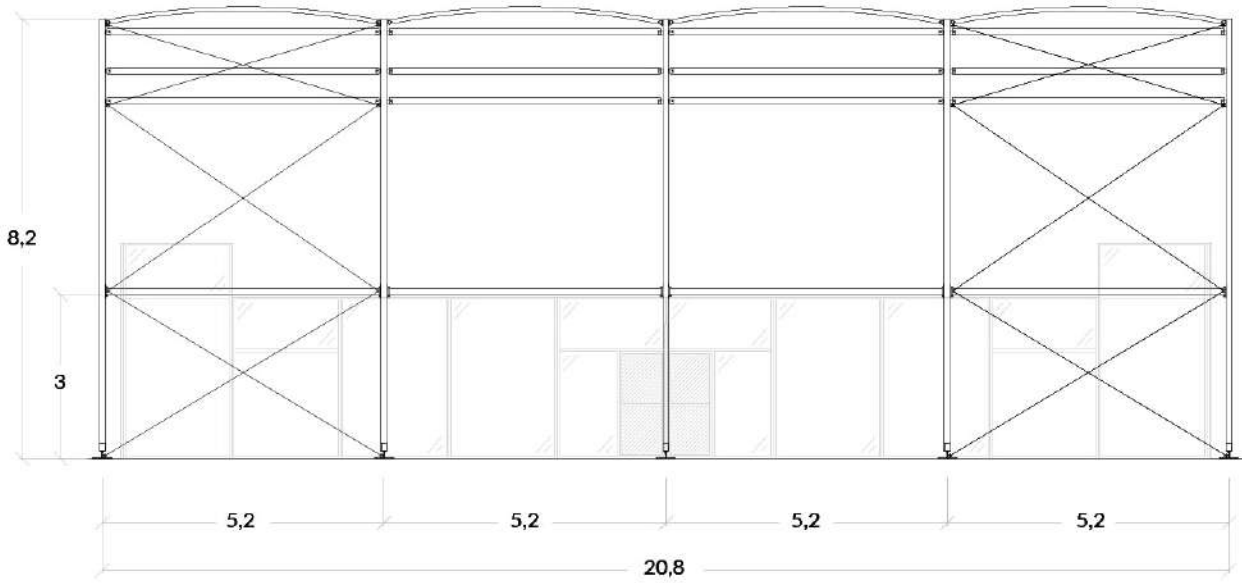

Top view | *Vue plan* | *Pianta* | *Planta*

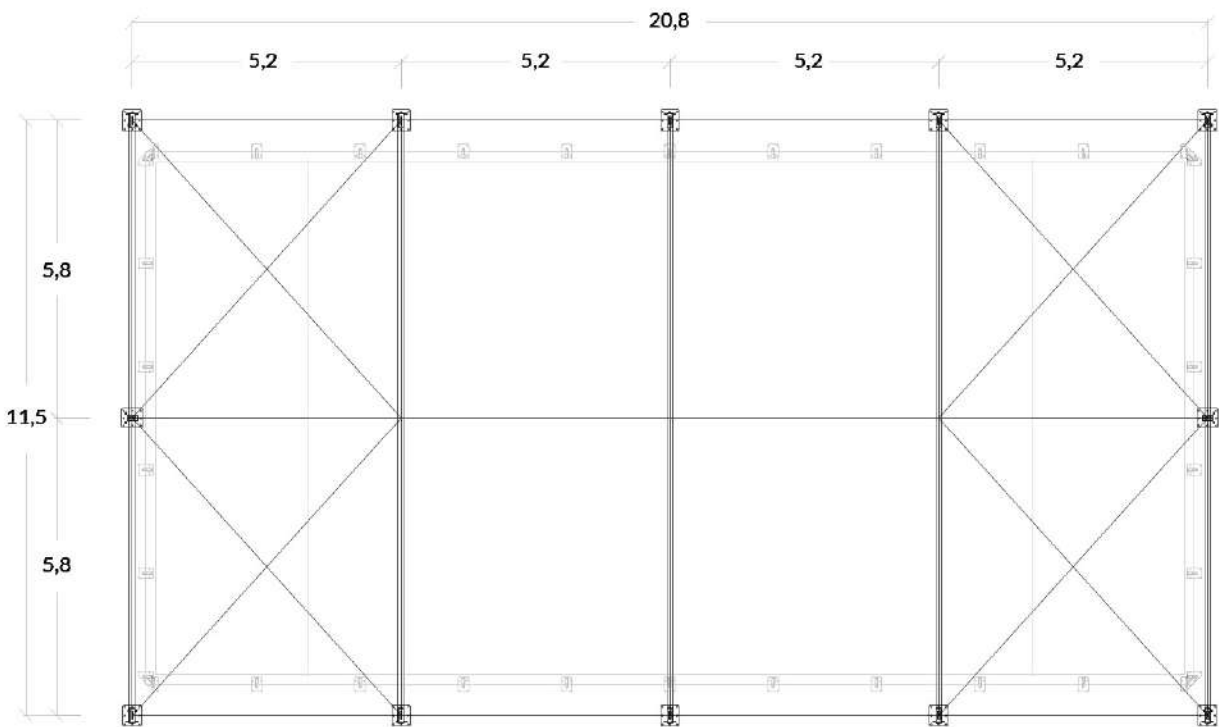

Top view double | *Vue plan double* | *Doppia pianta* | *Planta doble*

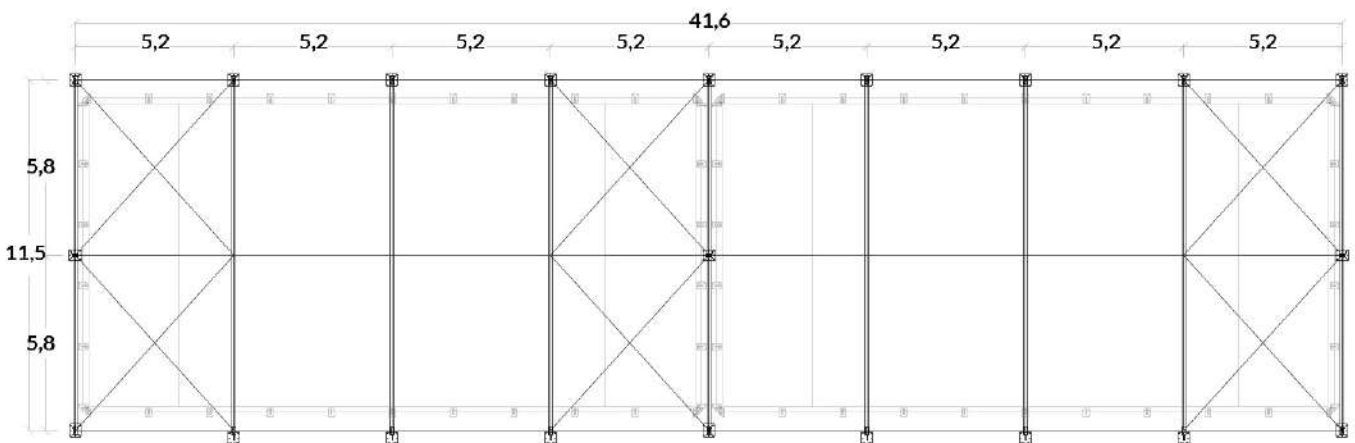



SINGLE PADEL MATCH 3.5

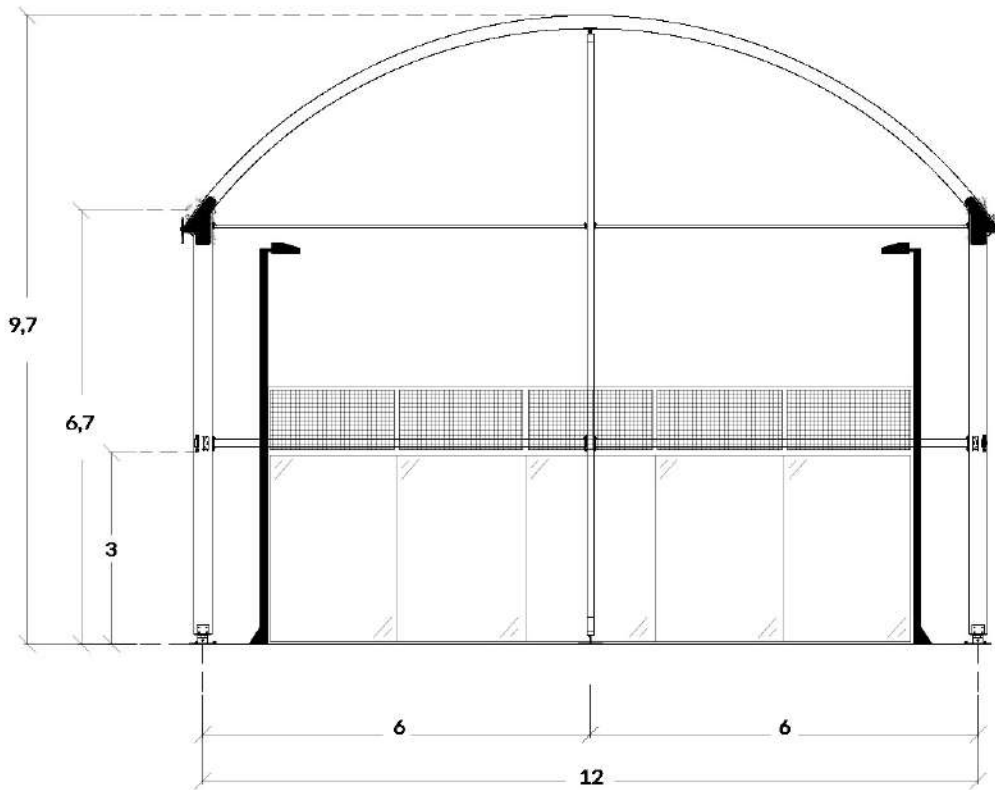

Courts number 1 / 2
Nombre de courts 1 / 2
Numero campi da gioco 1 / 2
Número de pistas 1 / 2



Fundations needed
Fondations nécessaires
Fondazioni necessarie
Cimentaciones necesarias



Very high snow loads
Charge de neige très élevée
Carico neve molto alto
Cargas de nieve muy alto



Allows outside play
Permet le jeu extérieur
Permette il gioco all'esterno
Permite juego exterior

Side view | Vue latérale | Vista laterale | Vista Lateral

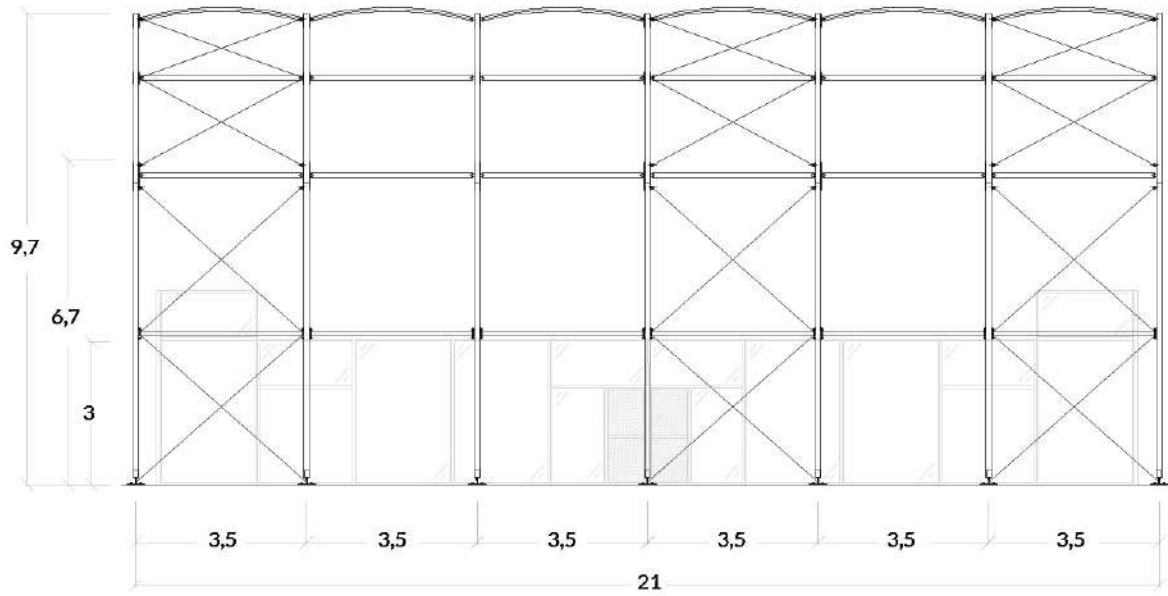

Top view | Vue plan | Pianta | Planta

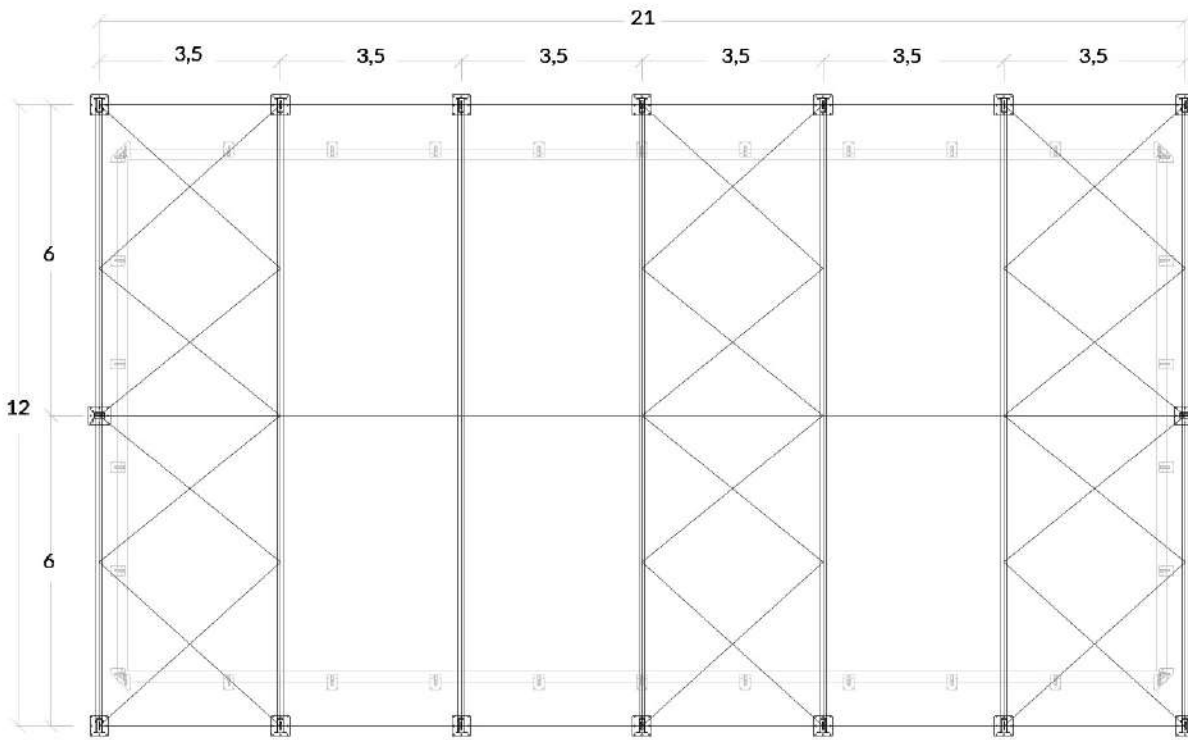

Top view double | Vue plan double | Doppia pianta | Planta doble

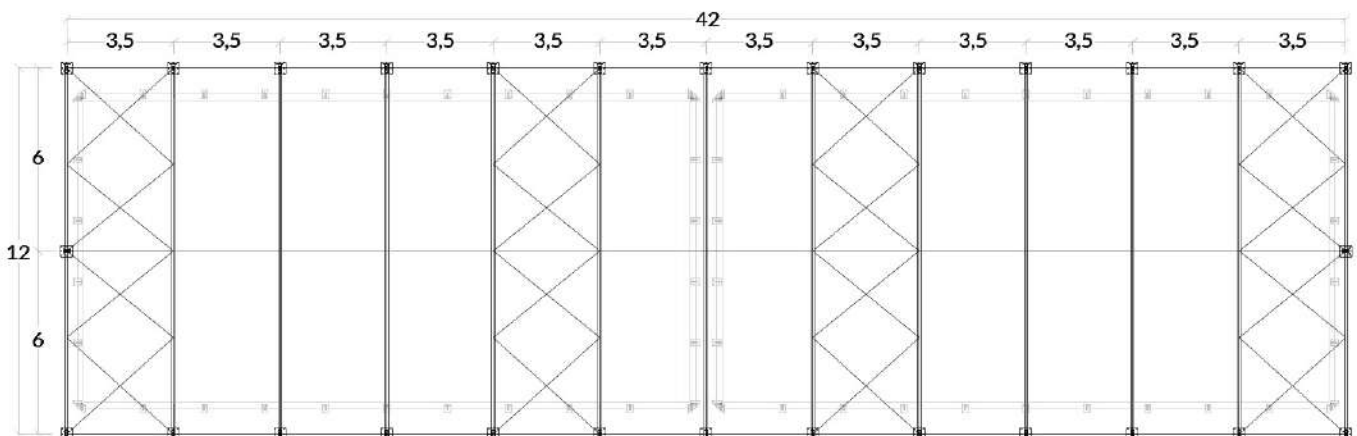



SINGLE PADEL MATCH 4.2

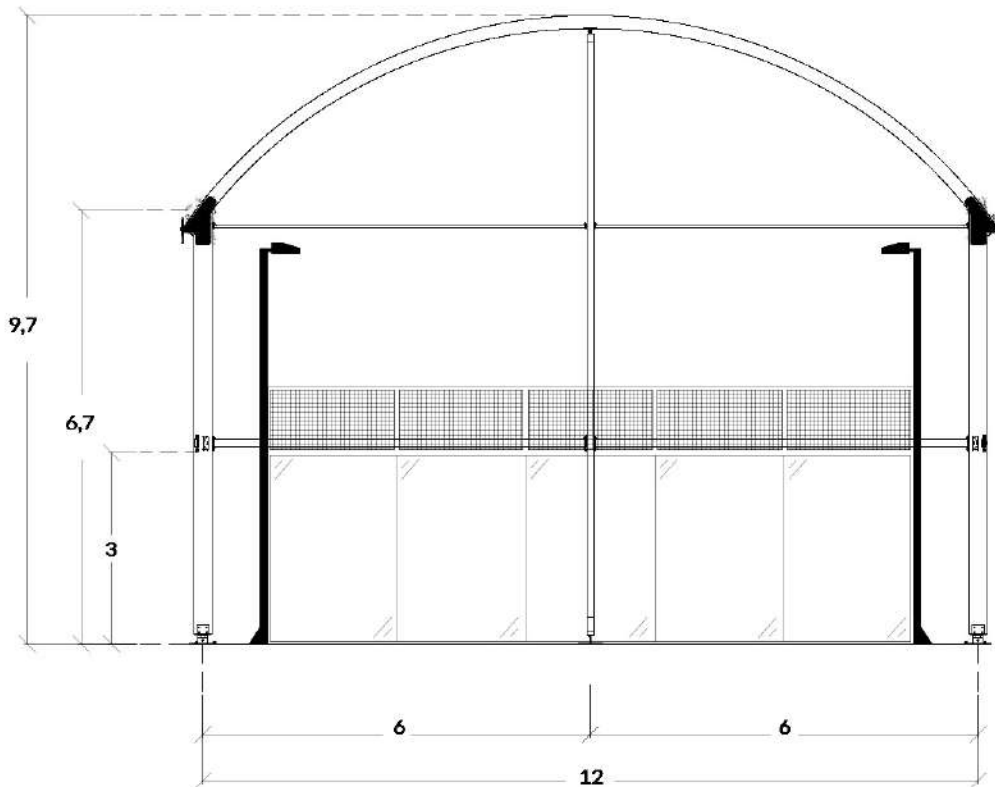

Courts number 1 / 2
Nombre de courts 1 / 2
Numero campi da gioco 1 / 2
Número de pistas 1 / 2



Fundations needed
Fondations nécessaires
Fondazioni necessarie
Cimentaciones necesarias



Very high snow loads
Charge de neige très élevée
Carico neve molto alto
Cargas de nieve muy alto



Allows outside play
Permet le jeu extérieur
Permette il gioco all'esterno
Permite juego exterior

Side view | Vue latérale | Vista laterale | Vista Lateral

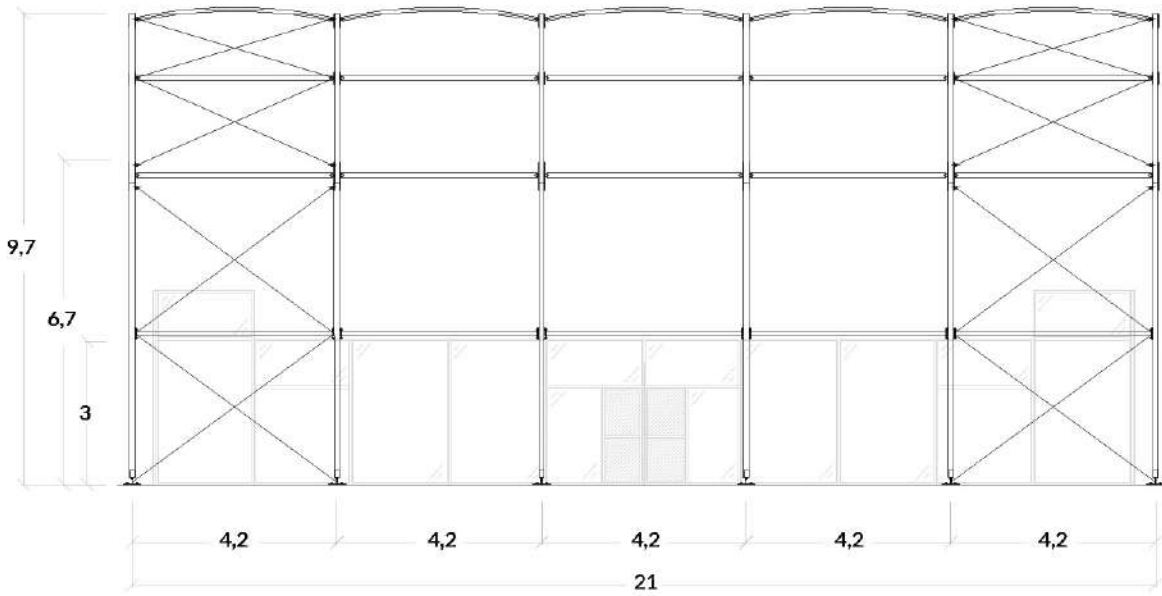

Top view | Vue plan | Pianta | Planta

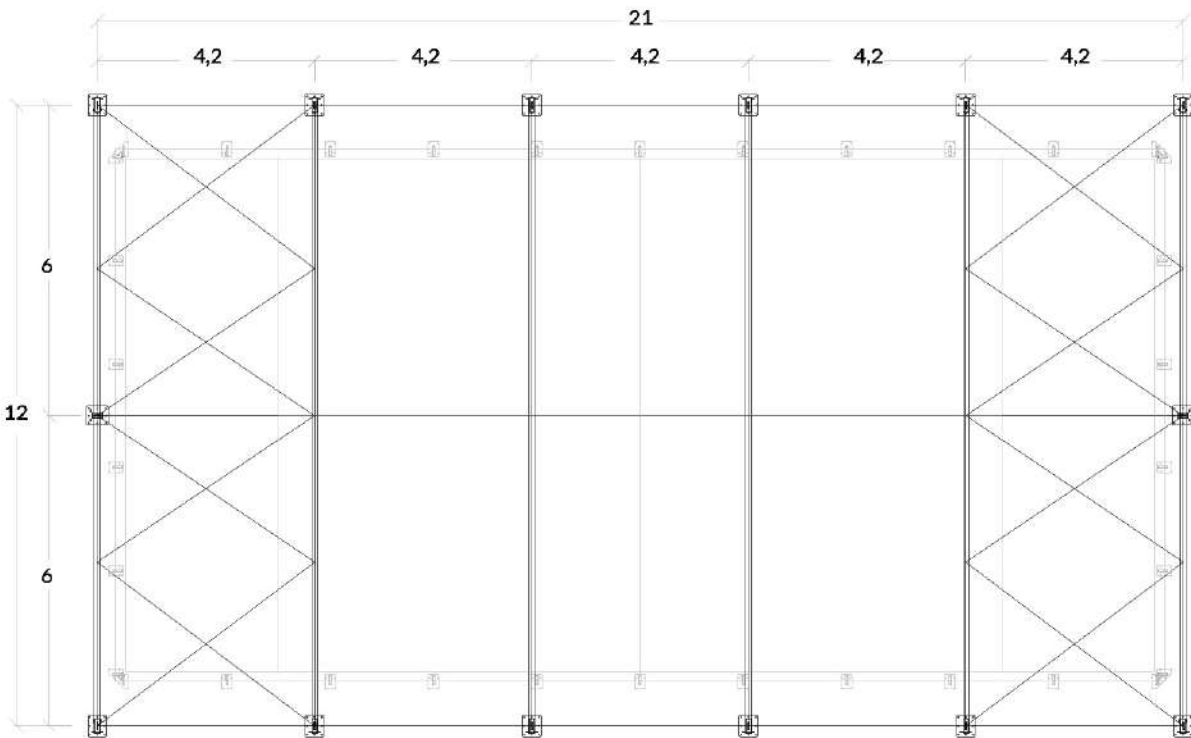

Top view double | Vue plan double | Doppia pianta | Planta doble

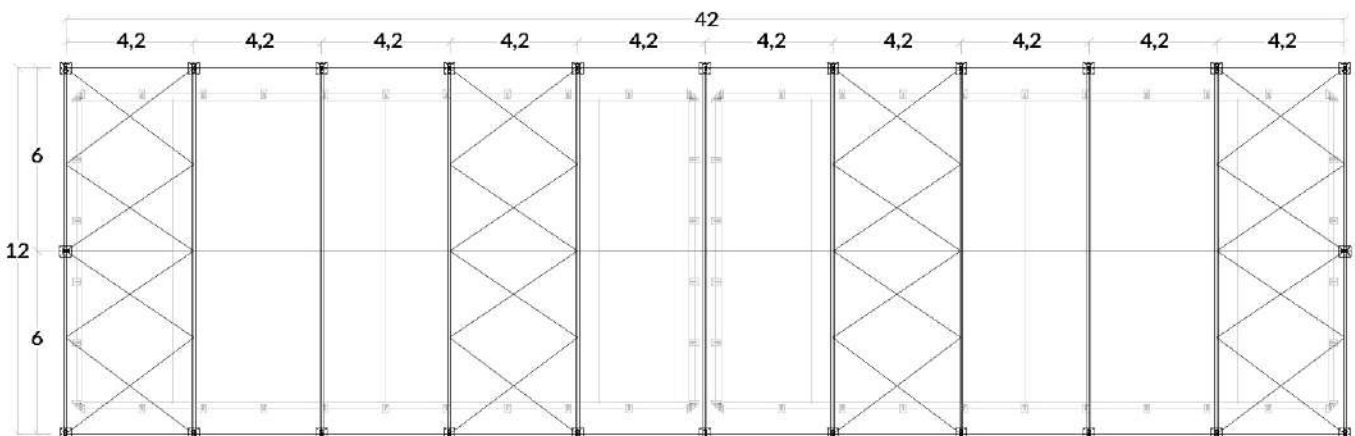



SINGLE PADEL MATCH 4.4

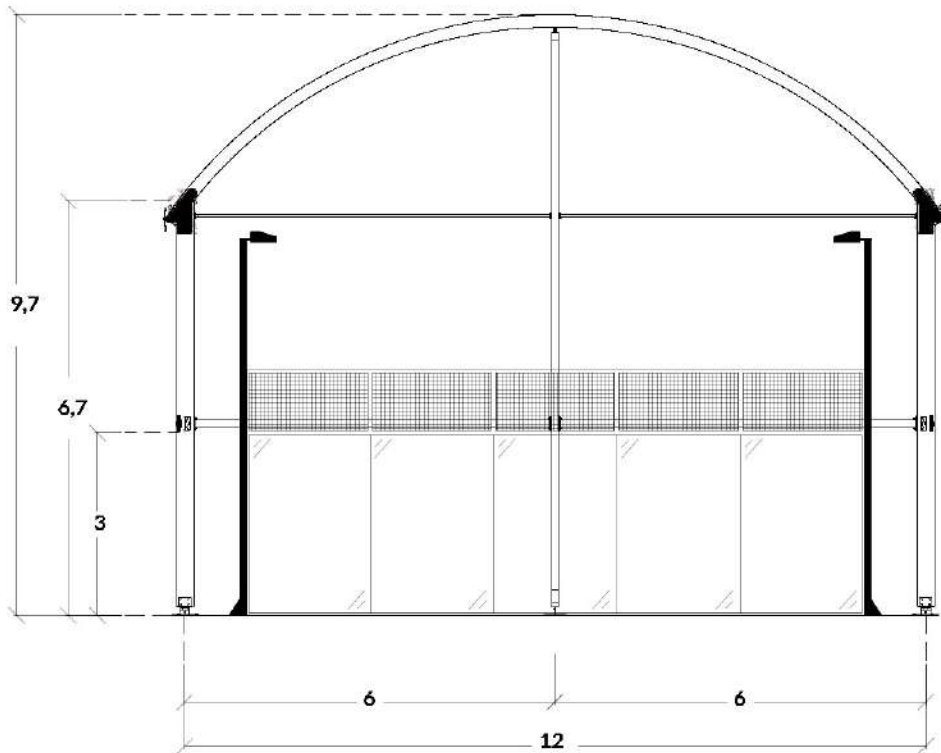

Courts number 1 / 2
Nombre de courts 1 / 2
Numero campi da gioco 1 / 2
Número de pistas 1 / 2



Fundations needed
Fondations nécessaires
Fondazioni necessarie
Cimentaciones necesarias



High snow loads
Charge de neige élevée
Carico neve alto
Cargas de nieve alto



Allows outside play
Permet le jeu extérieur
Permette il gioco all'esterno
Permite juego exterior

Side view | *Vue latérale* | *Vista laterale* | *Vista Lateral*

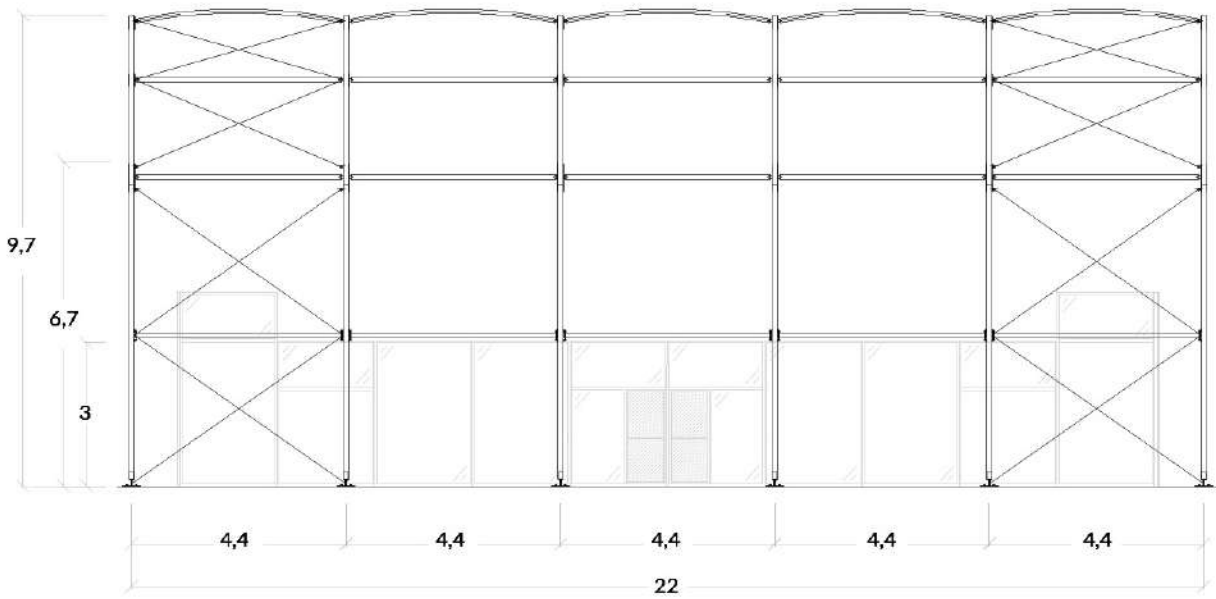

Top view | *Vue plan* | *Pianta* | *Planta*

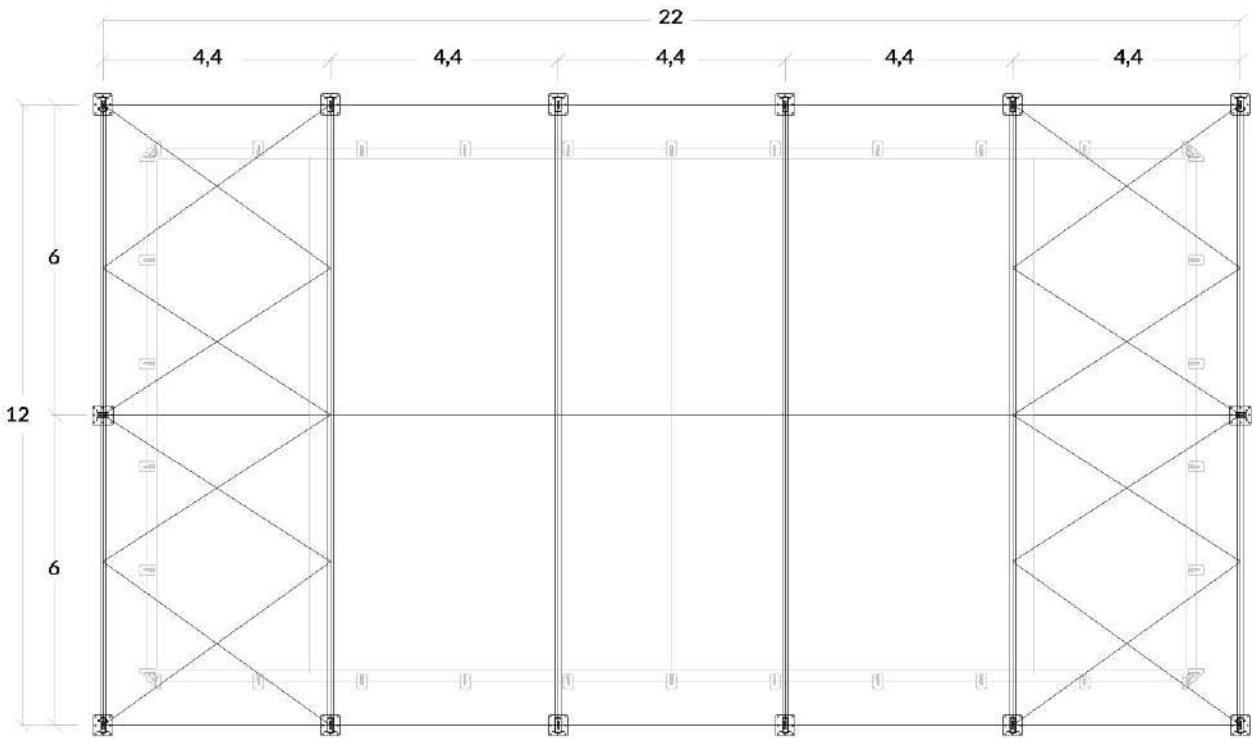

Top view double | *Vue plan double* | *Doppia pianta* | *Planta doble*

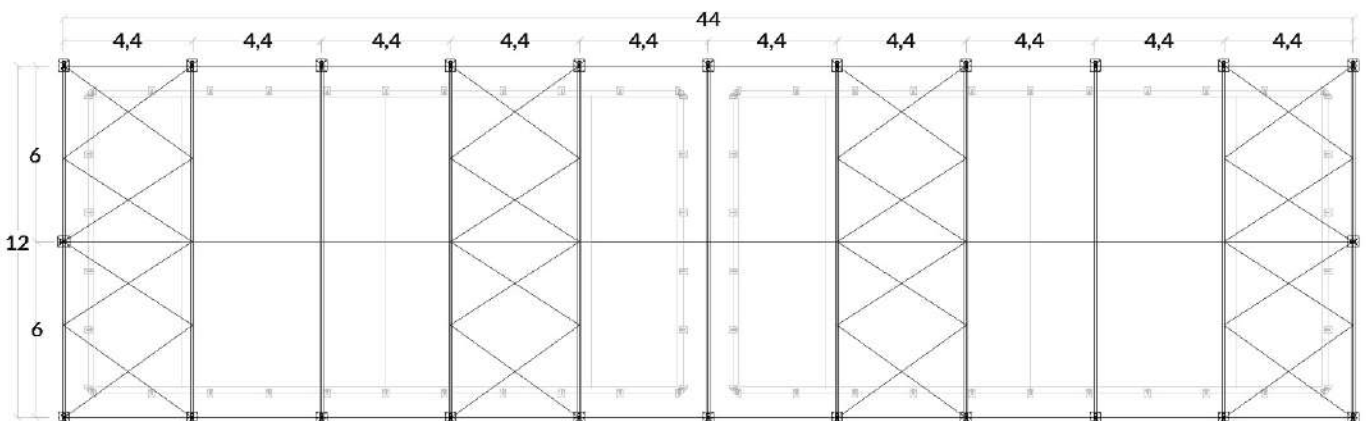



SINGLE PADEL MATCH 5.2

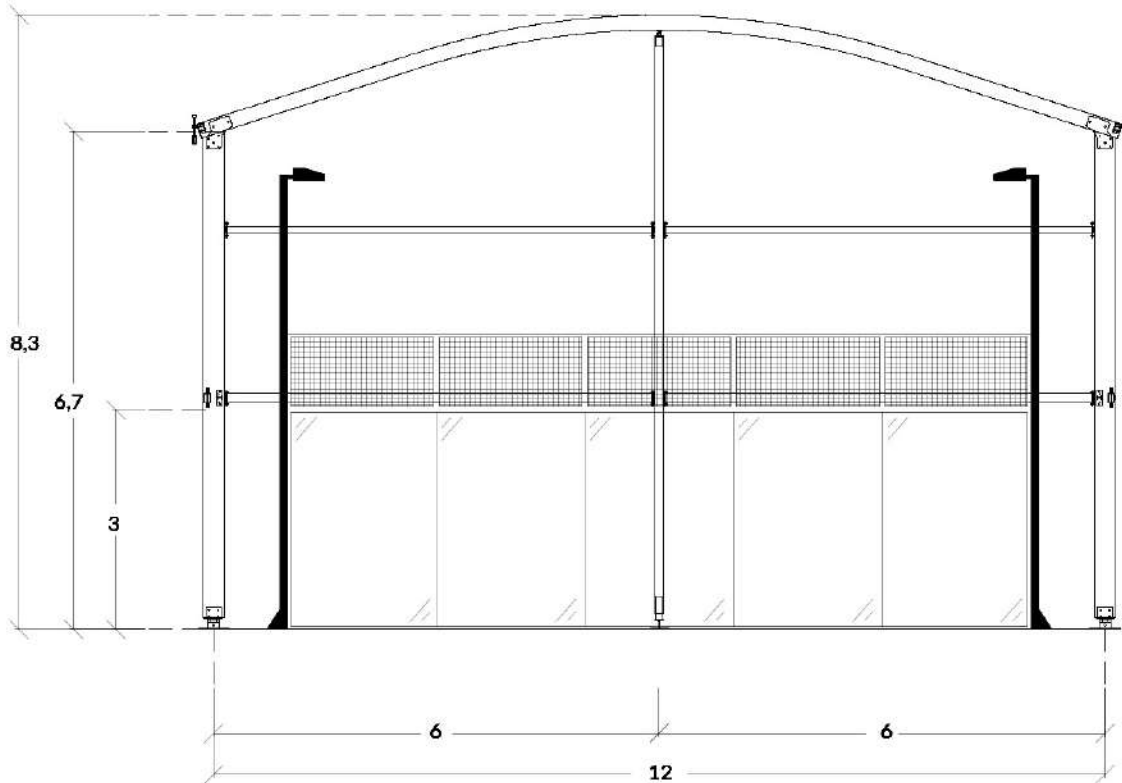

Courts number 1 / 2
Nombre de courts 1 / 2
Numero campi da gioco 1 / 2
Número de pistas 1 / 2



Fundations needed
Fondations nécessaires
Fondazioni necessarie
Cimentaciones necesarias



High snow loads
Charge de neige élevée
Carico neve alto
Cargas de nieve alto



Allows outside play
Permet le jeu extérieur
Permette il gioco all'esterno
Permite juego exterior

Side view | *Vue latérale* | *Vista laterale* | *Vista Lateral*

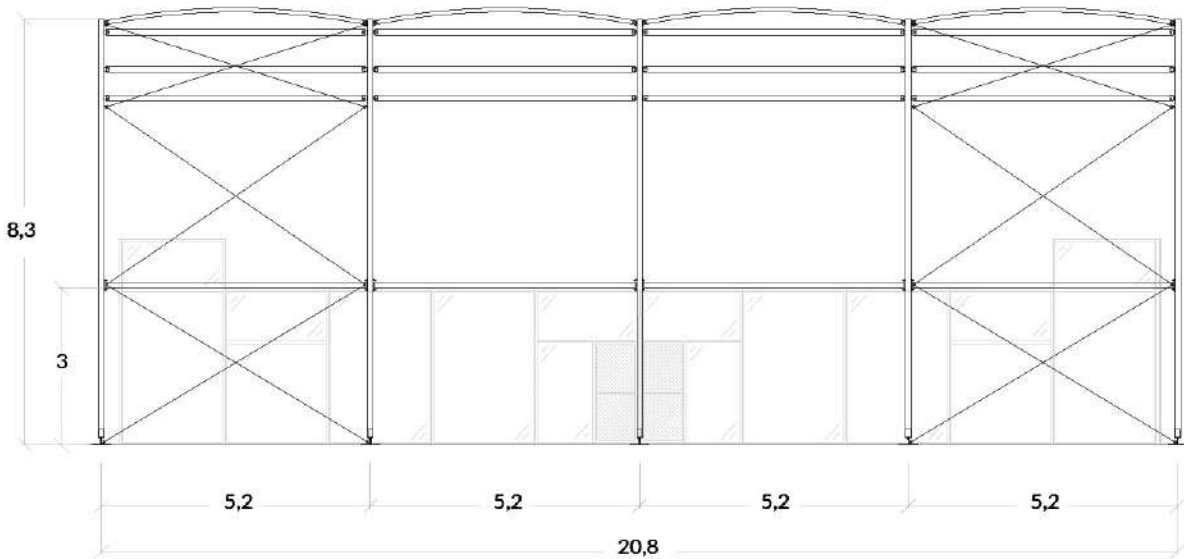

Top view | *Vue plan* | *Pianta* | *Planta*

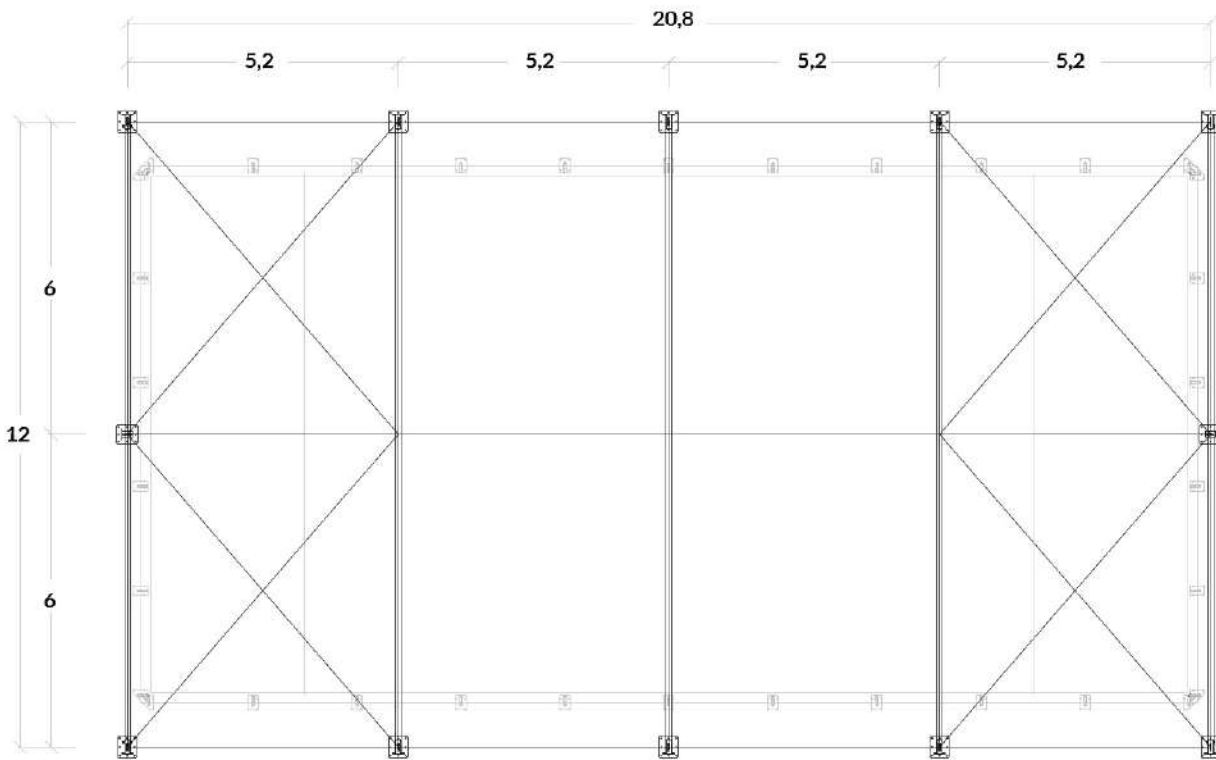

Top view double | *Vue plan double* | *Doppia pianta* | *Planta doble*

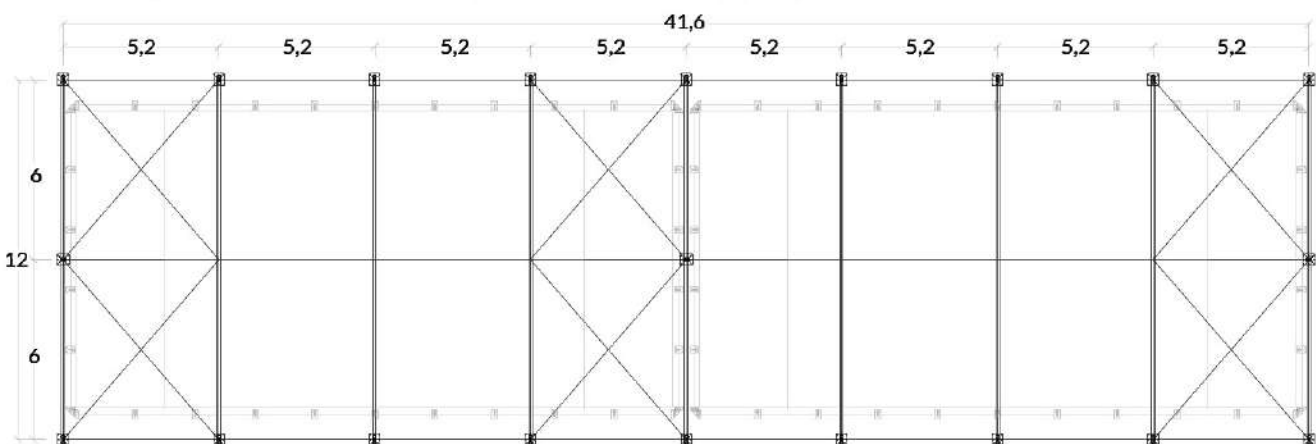



SINGLE PADEL MATCH 6.9

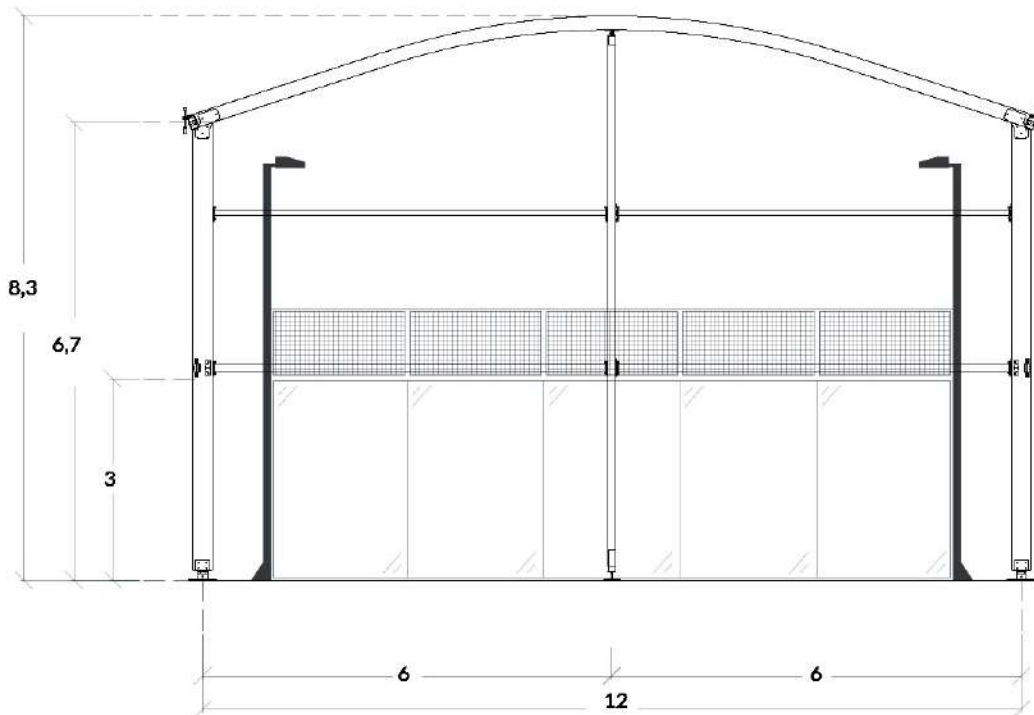

Courts number 1 / 2
Nombre de courts 1 / 2
Numero campi da gioco 1 / 2
Número de pistas 1 / 2



Fundations needed
Fondations nécessaires
Fondazioni necessarie
Cimentaciones necesarias



Medium snow loads
Charge de neige moyennes
Carico neve medio
Cargas de nieve media



Allows outside play
Permet le jeu extérieur
Permette il gioco all'esterno
Permite juego exterior

Side view | *Vue latérale* | *Vista laterale* | *Vista Lateral*

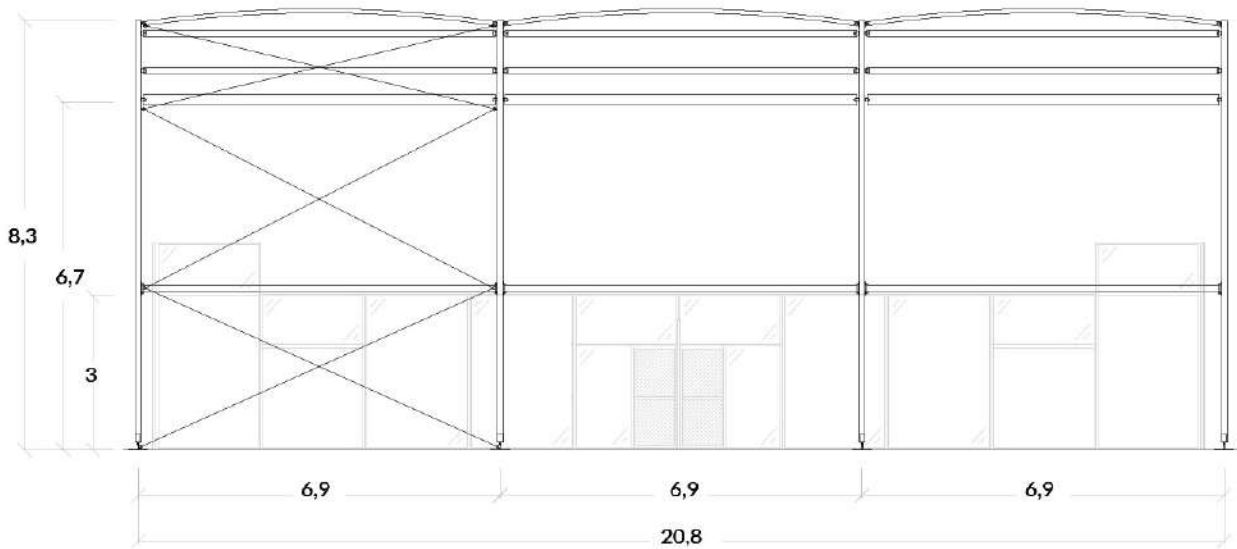

Top view | *Vue plan* | *Pianta* | *Planta*

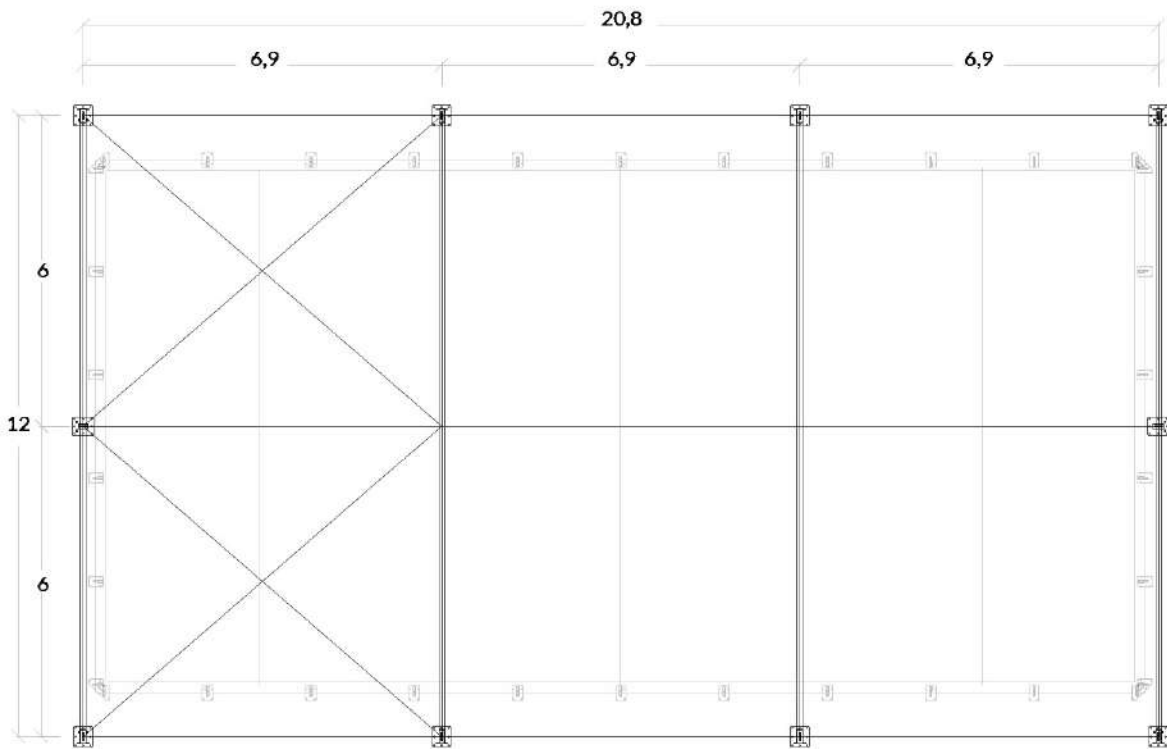

Top view double | *Vue plan double* | *Doppia pianta* | *Planta doble*

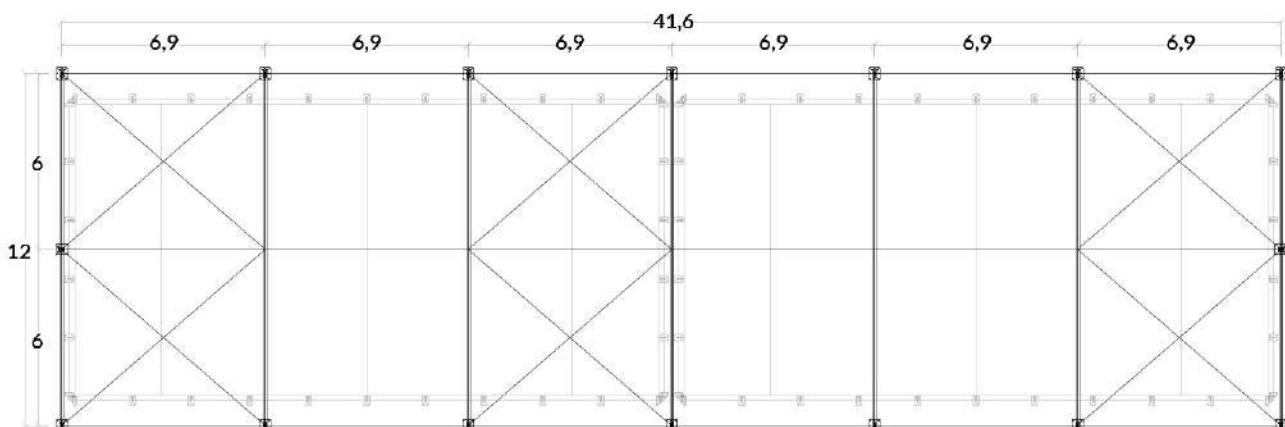



SINGLE PADEL SMASH 4.4

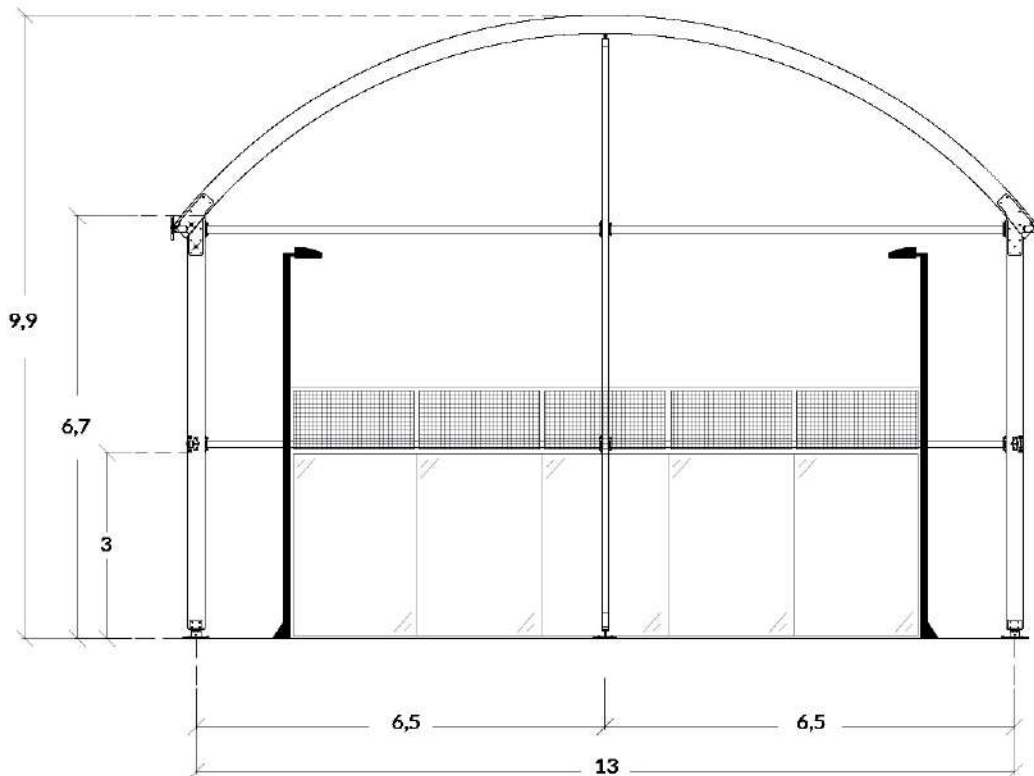

Courts number 1 / 2
Nombre de courts 1 / 2
Numero campi da gioco 1 / 2
Número de pistas 1 / 2



Fundations needed
Fondations nécessaires
Fondazioni necessarie
Cimentaciones necesarias



Very high snow loads
Charge de neige très élevée
Carico neve molto alto
Cargas de nieve muy alto



Allows outside play
Permet le jeu extérieur
Permette il gioco all'esterno
Permite juego exterior

Side view | Vue latérale | Vista laterale | Vista Lateral

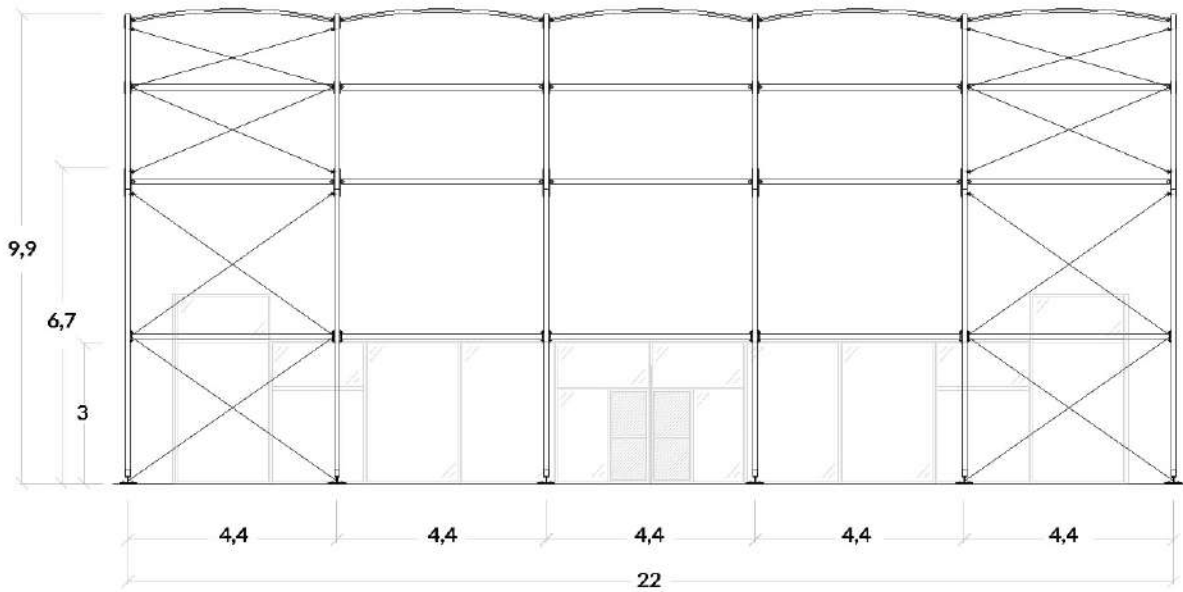

Top view | Vue plan | Pianta | Planta

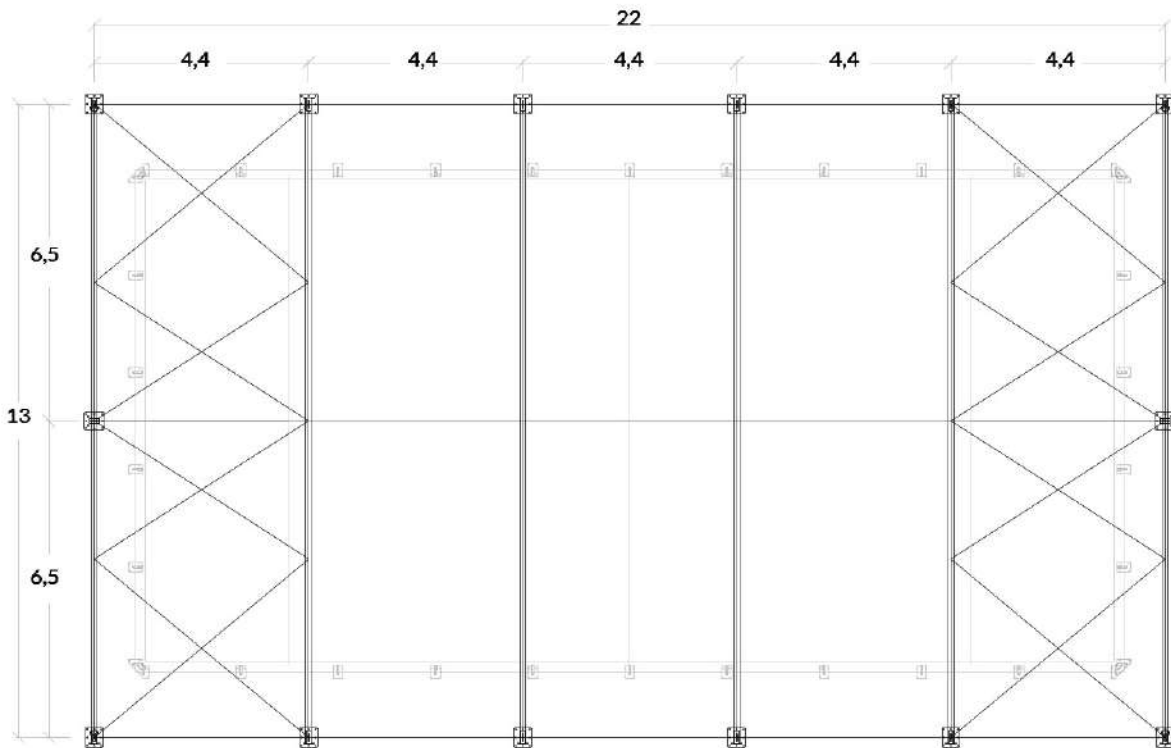

Top view double | Vue plan double | Doppia pianta | Planta doble

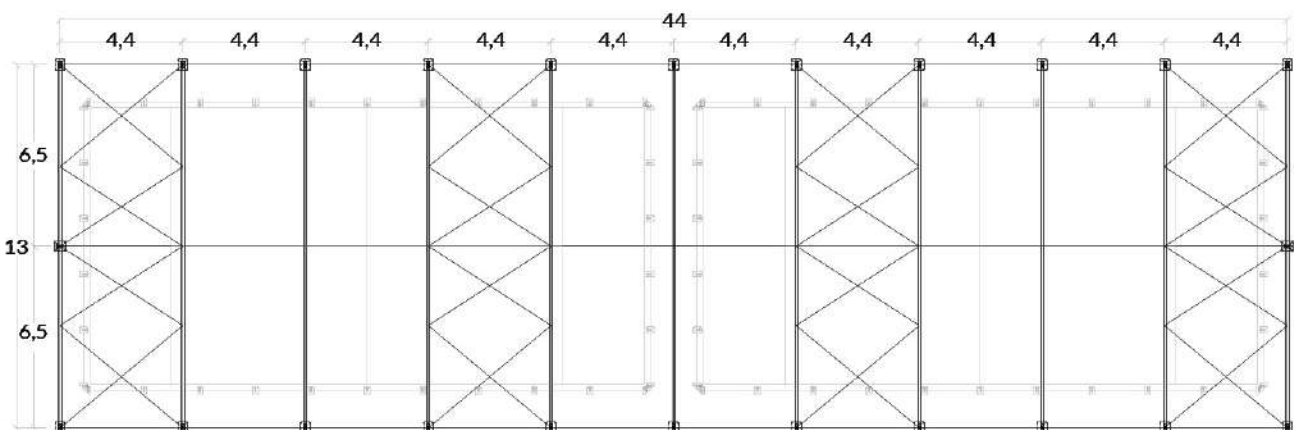



SINGLE PADEL SMASH 5.2

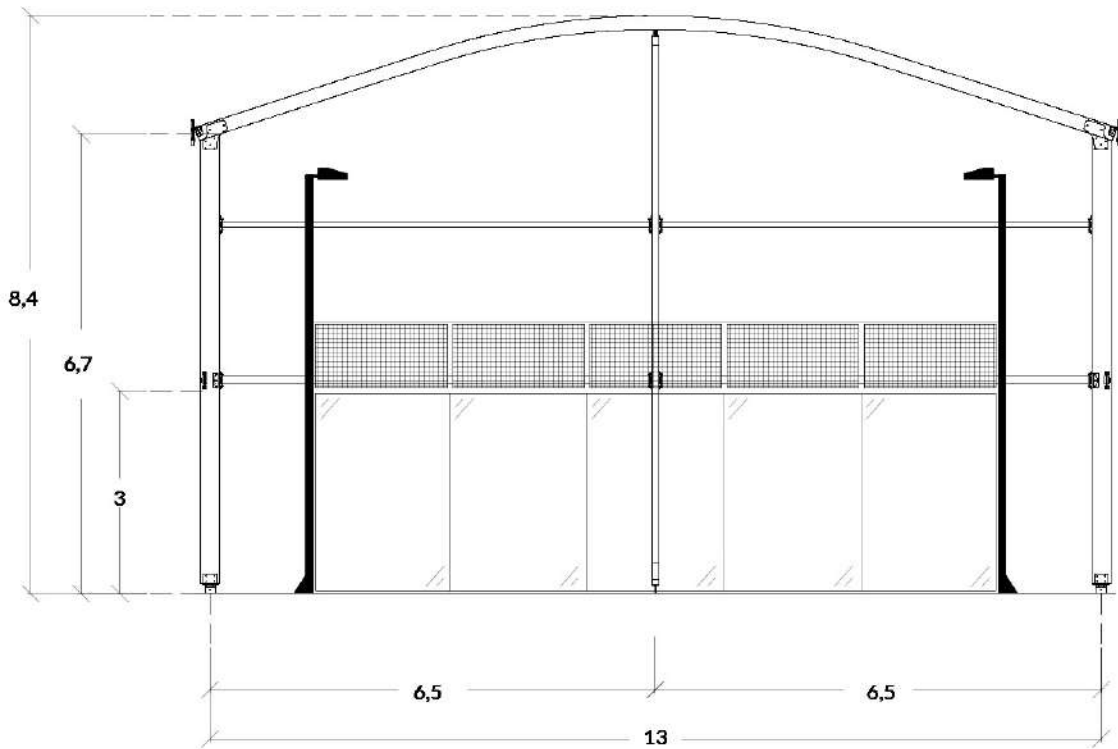

Courts number 1 / 2
Nombre de courts 1 / 2
Numero campi da gioco 1 / 2
Número de pistas 1 / 2



Fundations needed
Fondations nécessaires
Fondazioni necessarie
Cimentaciones necesarias



High snow loads
Charge de neige élevée
Carico neve alto
Cargas de nieve alto



Allows outside play
Permet le jeu extérieur
Permette il gioco all'esterno
Permite juego exterior

Side view | Vue latérale | Vista laterale | Vista Lateral

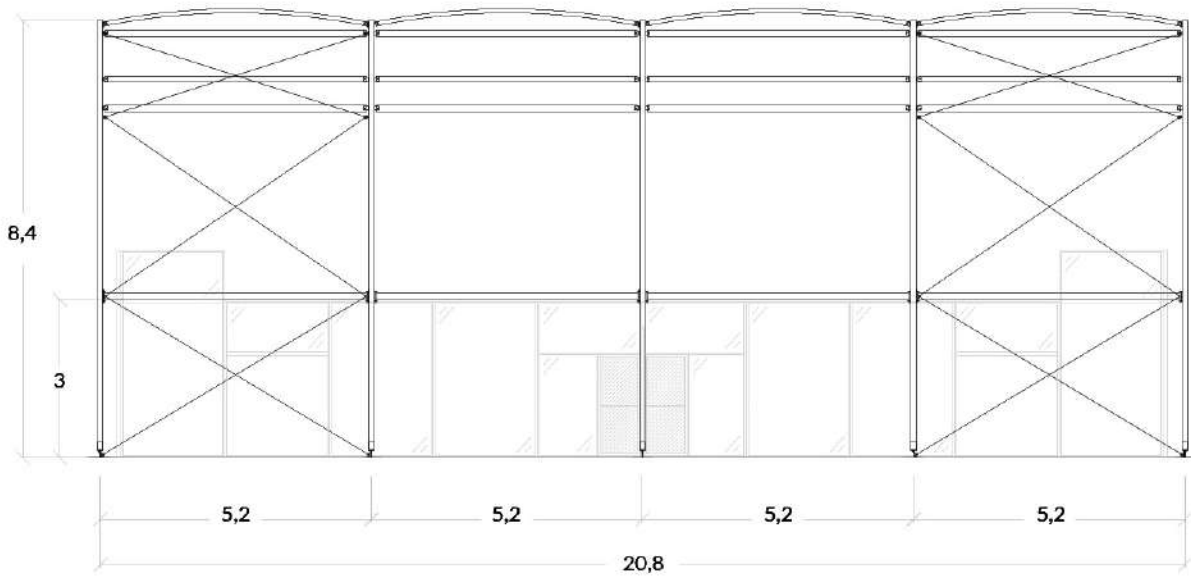

Top view | Vue plan | Pianta | Planta

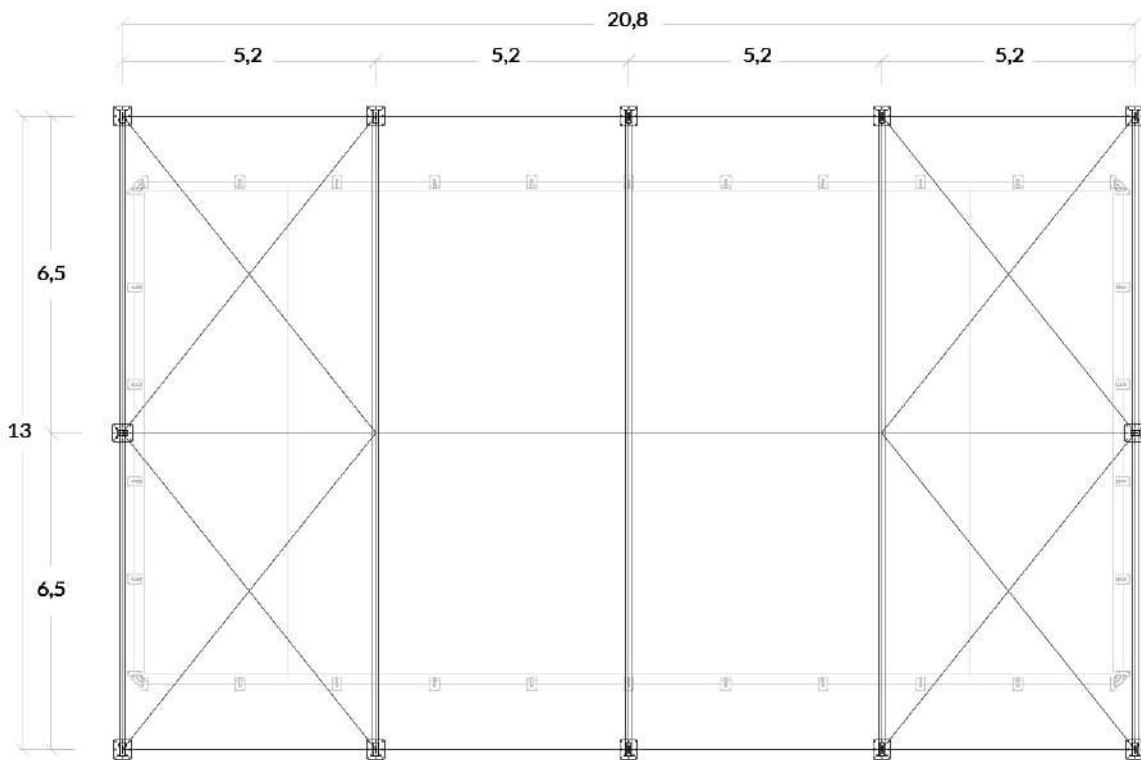

Top view double | Vue plan double | Doppia pianta | Planta doble

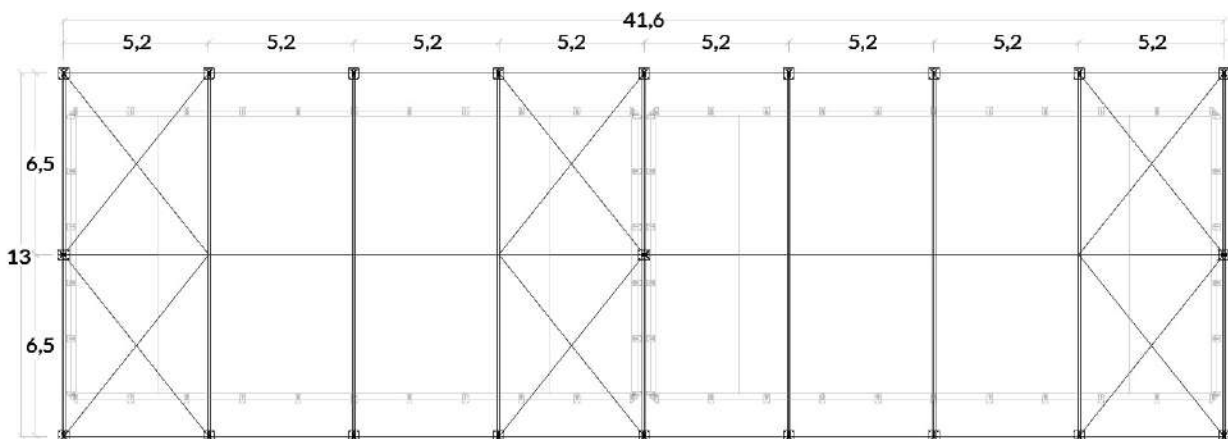



SINGLE PADEL COURT 6.3/8

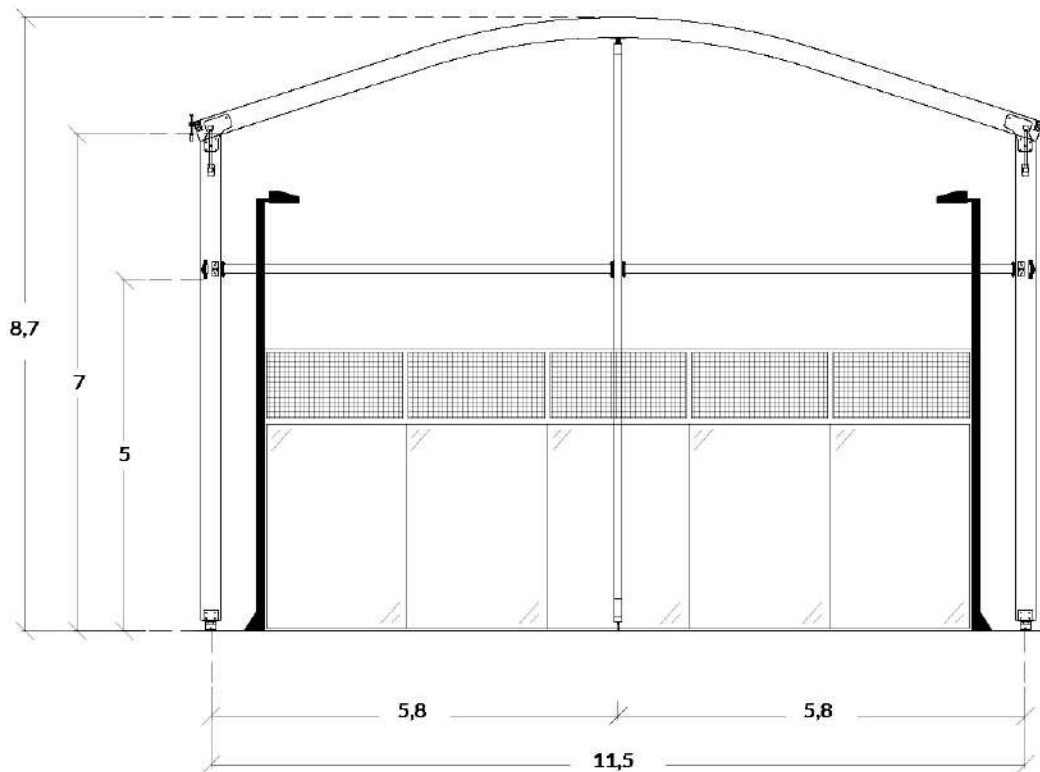

Courts number 1 / 2
Nombre de courts 1 / 2
Numero campi da gioco 1 / 2
Número de pistas 1 / 2



Fundations needed
Fondations nécessaires
Fondazioni necessarie
Cimentaciones necesarias



Medium snow loads
Charge de neige moyenne
Carico neve medio
Cargas de nieve media



Allows outside play
Permet le jeu extérieur
Permette il gioco all'esterno
Permite juego exterior

Side view | Vue latérale | Vista laterale | Vista Lateral

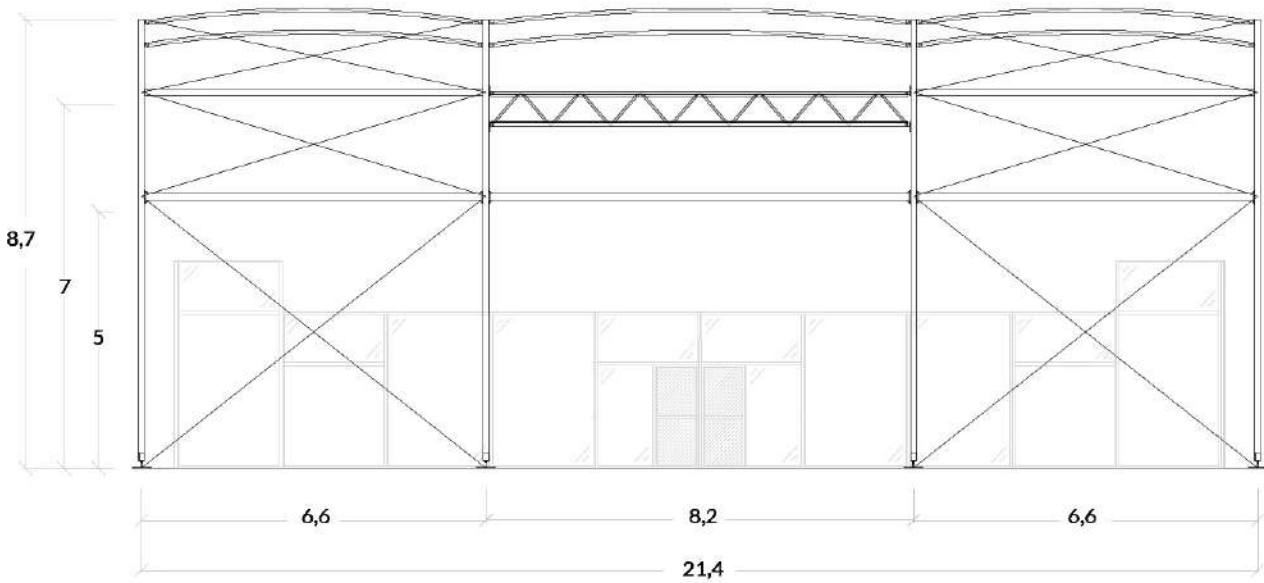

Top view | Vue plan | Pianta | Planta

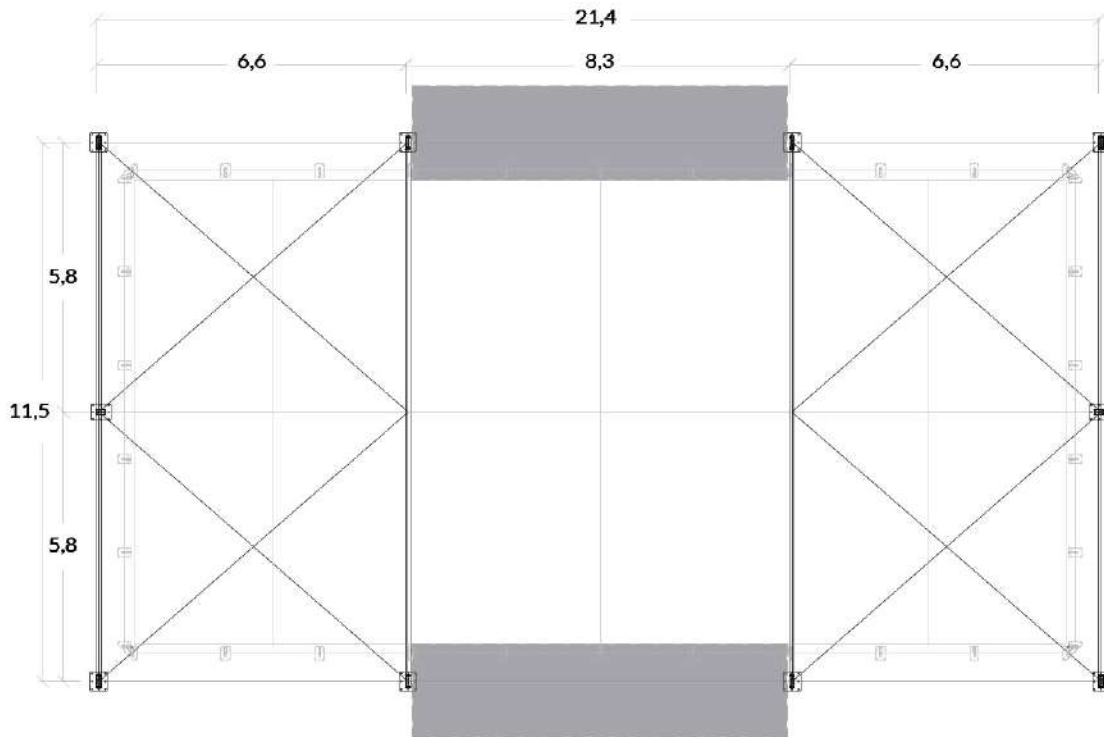

Top view double | Vue plan double | Doppia pianta | Planta doble

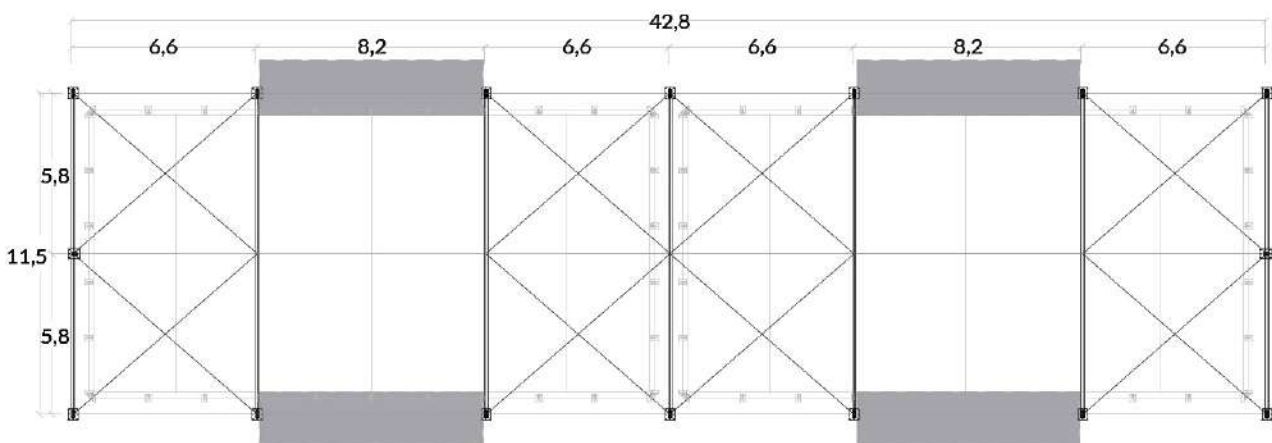



SINGLE PADEL BREAK 12

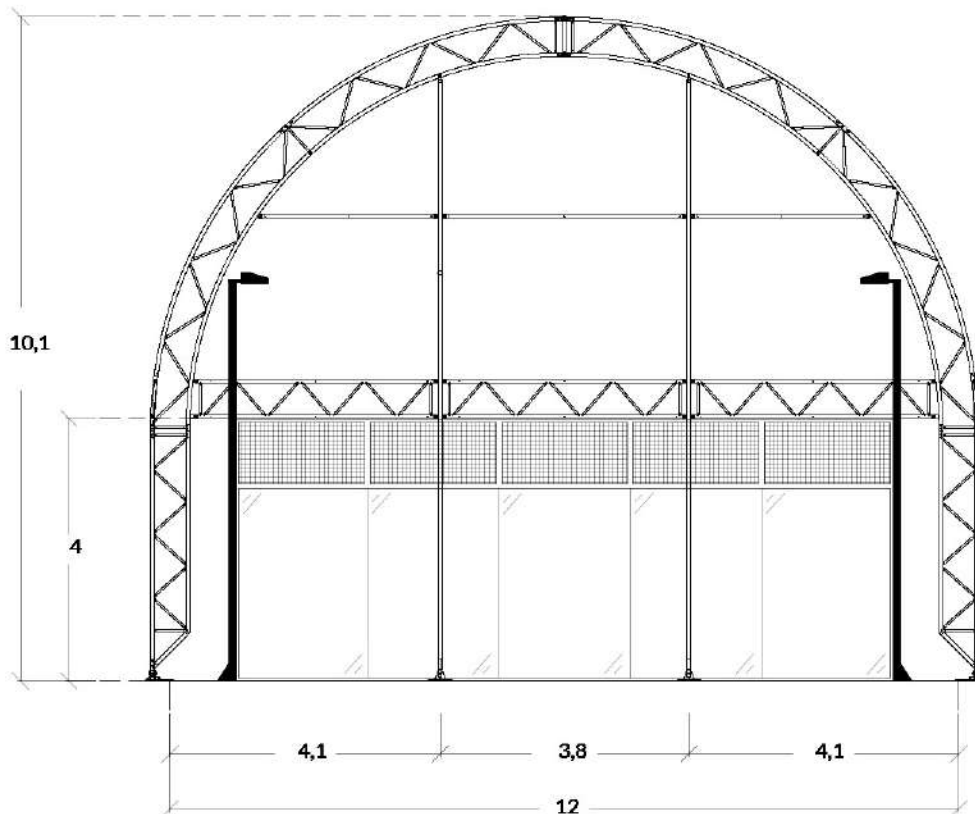

Courts number 1 / 2
Nombre de courts 1 / 2
Numero campi da gioco 1 / 2
Número de pistas 1 / 2



Fundations needed
Fondations nécessaires
Fondazioni necessarie
Cimentaciones necesarias



Medium snow loads
Charge de neige moyennes
Carico neve medio
Cargas de nieve media



Allows outside play
Permet le jeu extérieur
Permette il gioco all'esterno
Permite juego exterior

Side view | Vue latérale | Vista laterale | Vista Lateral

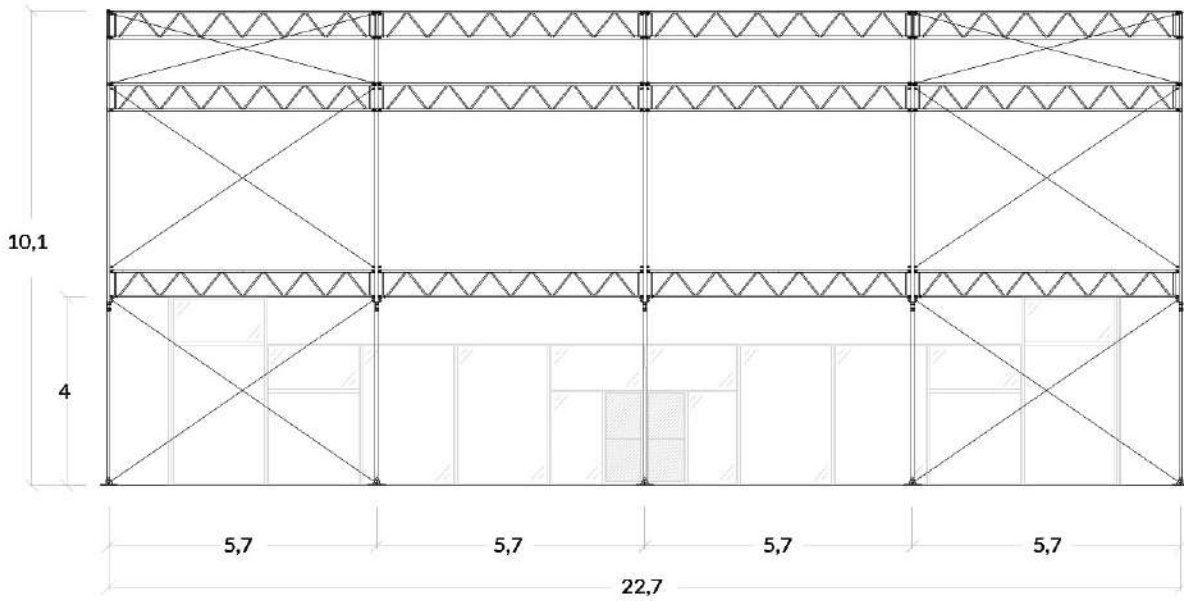

Top view | Vue plan | Pianta | Planta

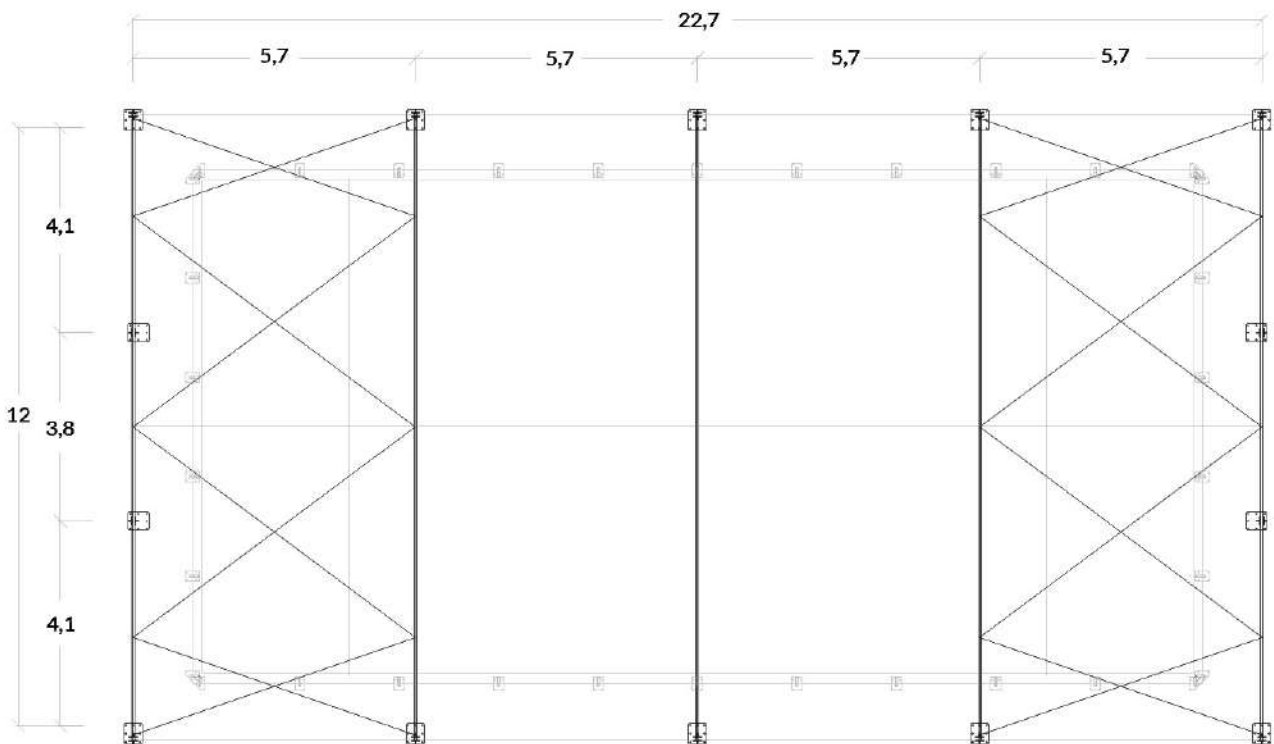

Top view double | Vue plan double | Doppia pianta | Planta doble

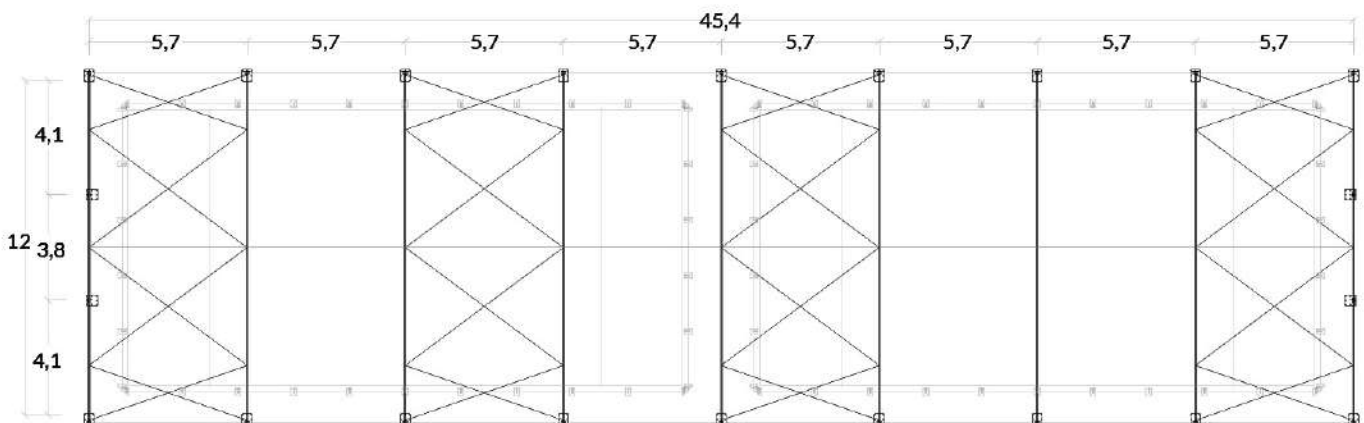



SINGLE PADEL BREAK 13

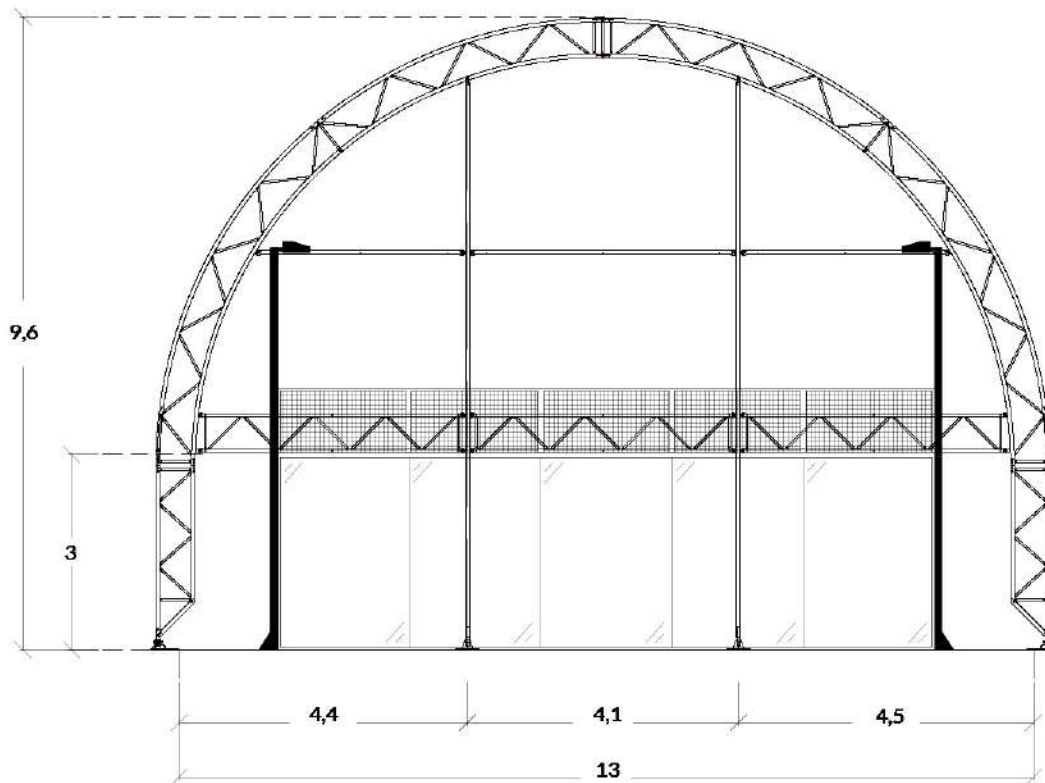

Courts number 1 / 2
Nombre de courts 1 / 2
Numero campi da gioco 1 / 2
Número de pistas 1 / 2



Fundations needed
Fondations nécessaires
Fondazioni necessarie
Cimentaciones necesarias



Medium snow loads
Charge de neige moyennes
Carico neve medio
Cargas de nieve media



Allows outside play
Permet le jeu extérieur
Permette il gioco all'esterno
Permite juego exterior

Side view | Vue latérale | Vista laterale | Vista Lateral

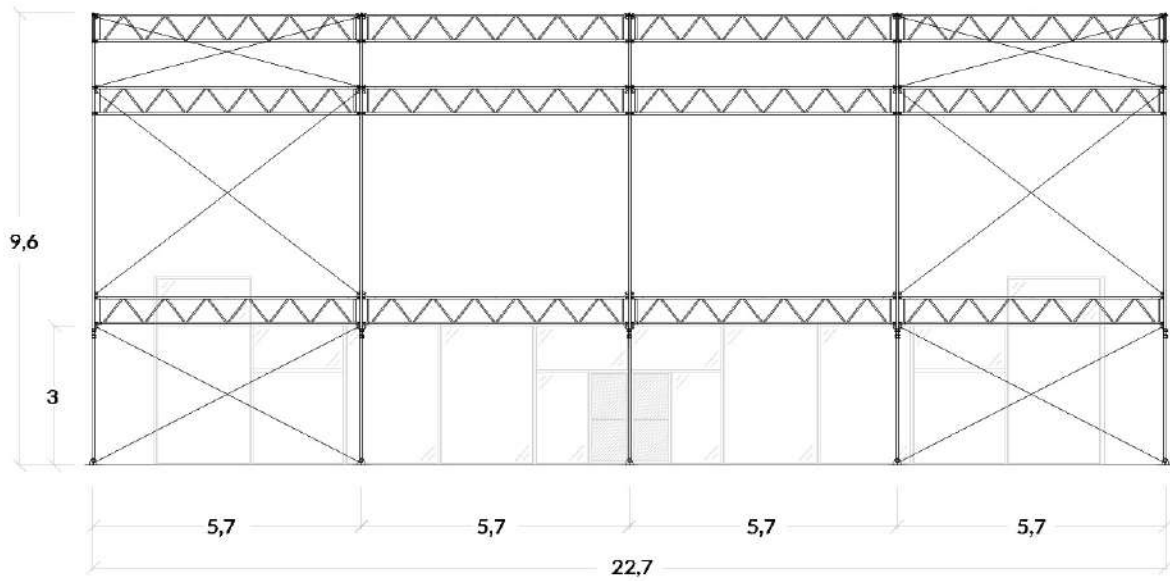

Top view | Vue plan | Pianta | Planta

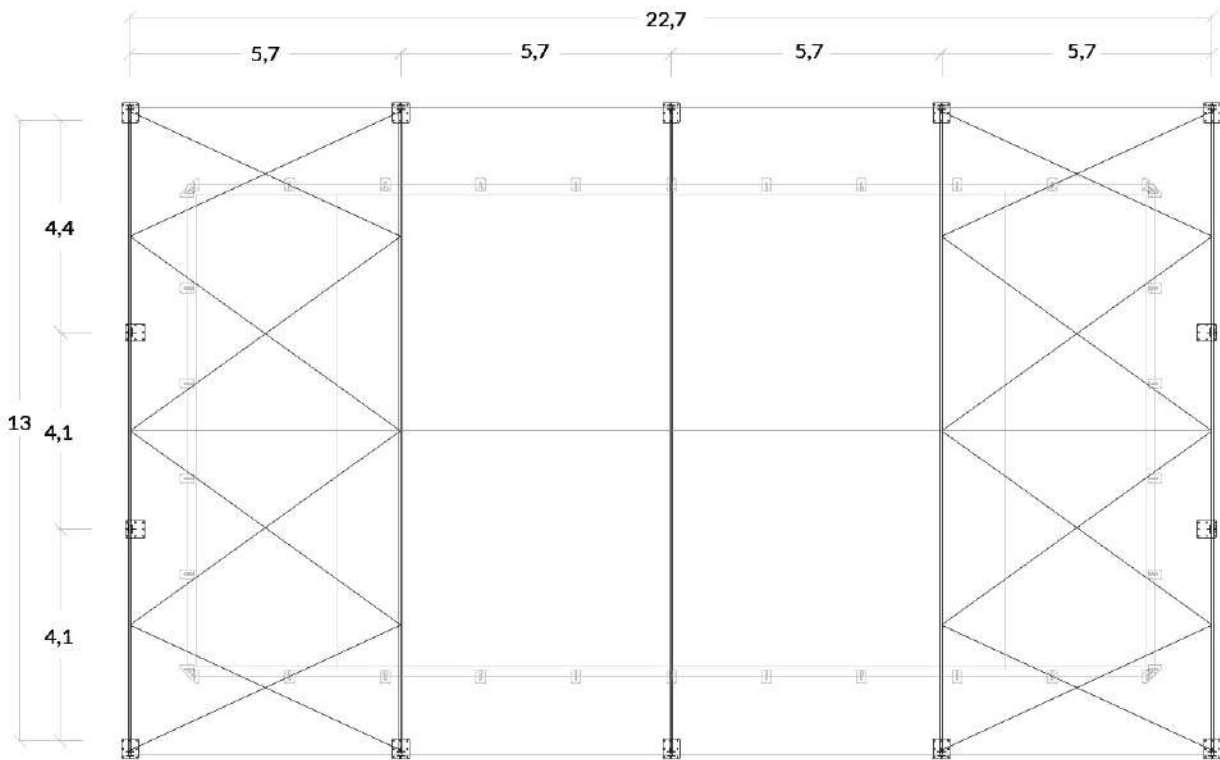

Top view double | Vue plan double | Doppia pianta | Planta doble

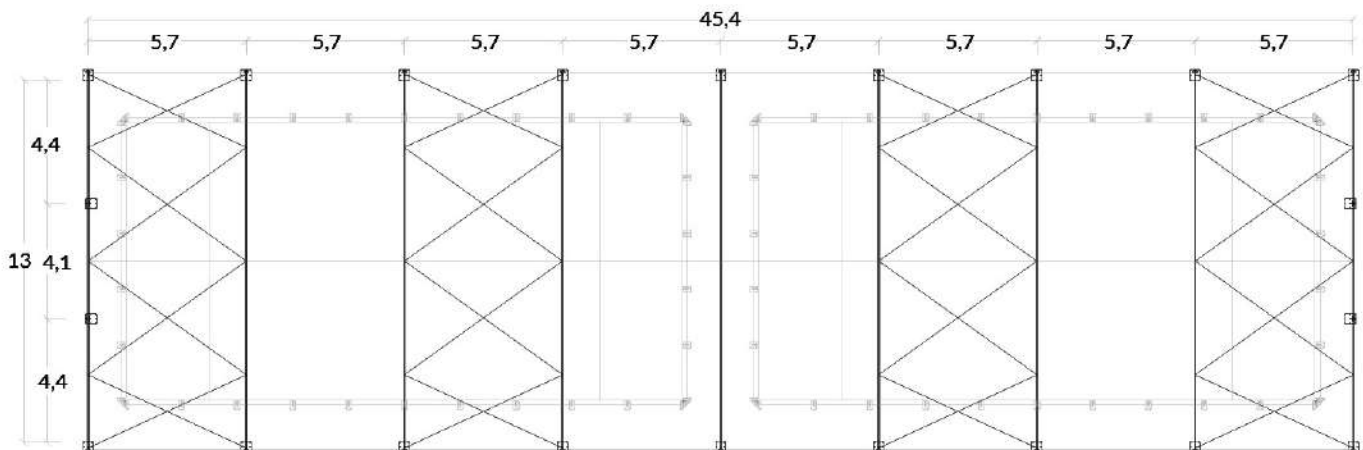



SINGLE PADEL BREAK 14

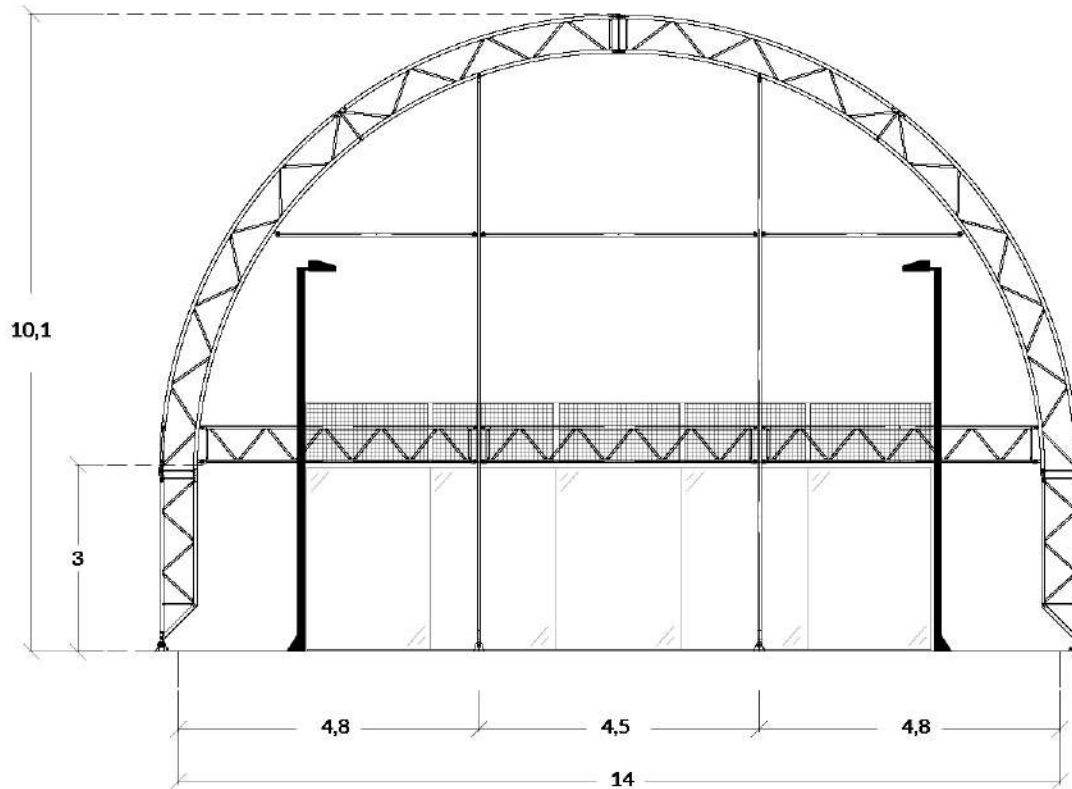

Courts number 1 / 2
Nombre de courts 1 / 2
Numero campi da gioco 1 / 2
Número de pistas 1 / 2



Fundations needed
Fondations nécessaires
Fondazioni necessarie
Cimentaciones necesarias



Medium snow loads
Charge de neige moyennes
Carico neve medio
Cargas de nieve media



Allows outside play
Permet le jeu extérieur
Permette il gioco all'esterno
Permite juego exterior

Side view | Vue latérale | Vista laterale | Vista Lateral

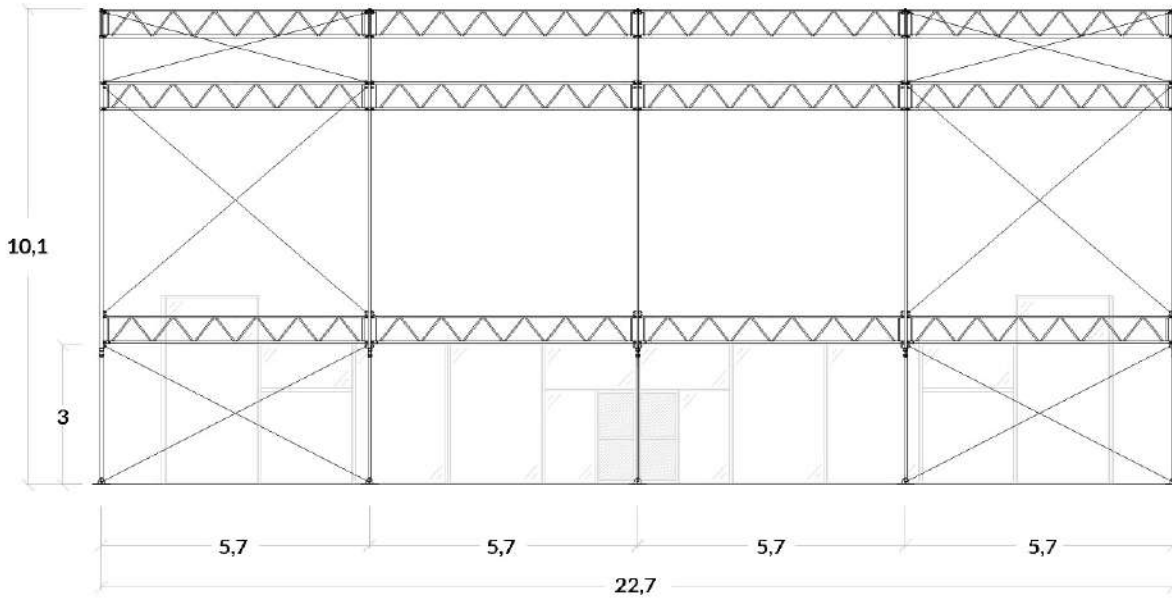

Top view | Vue plan | Pianta | Planta

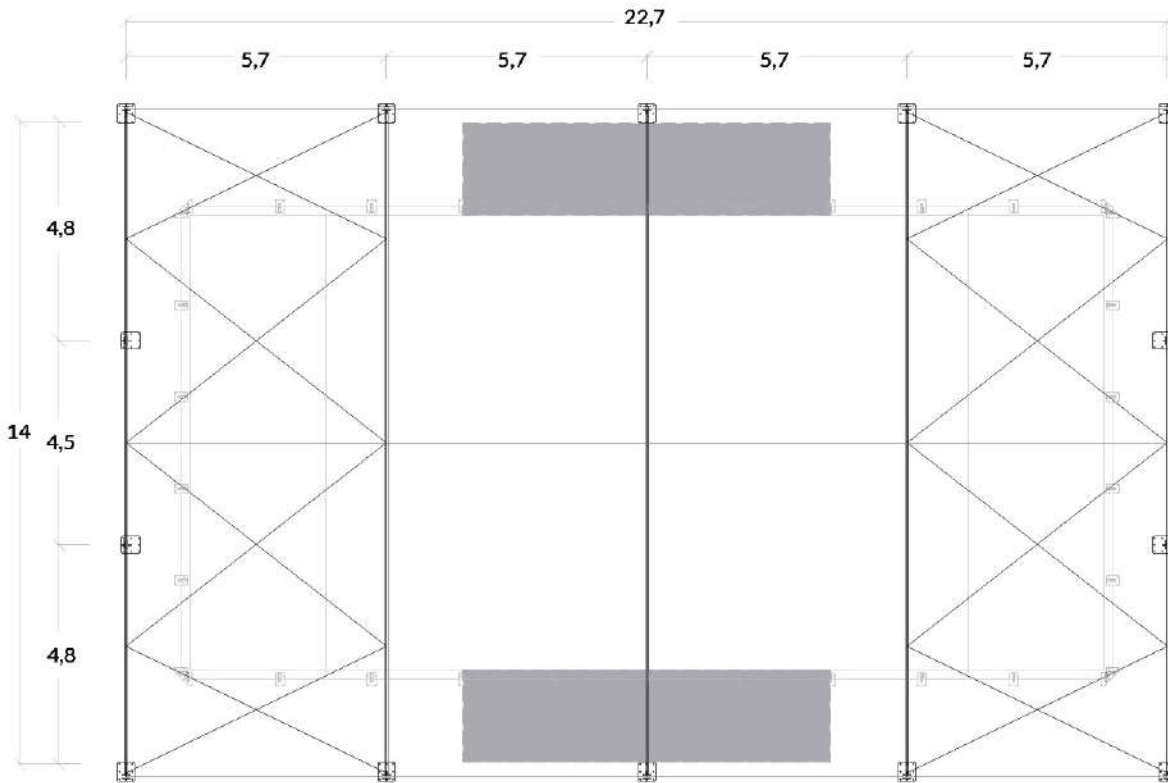

Top view double | Vue plan double | Doppia pianta | Planta doble

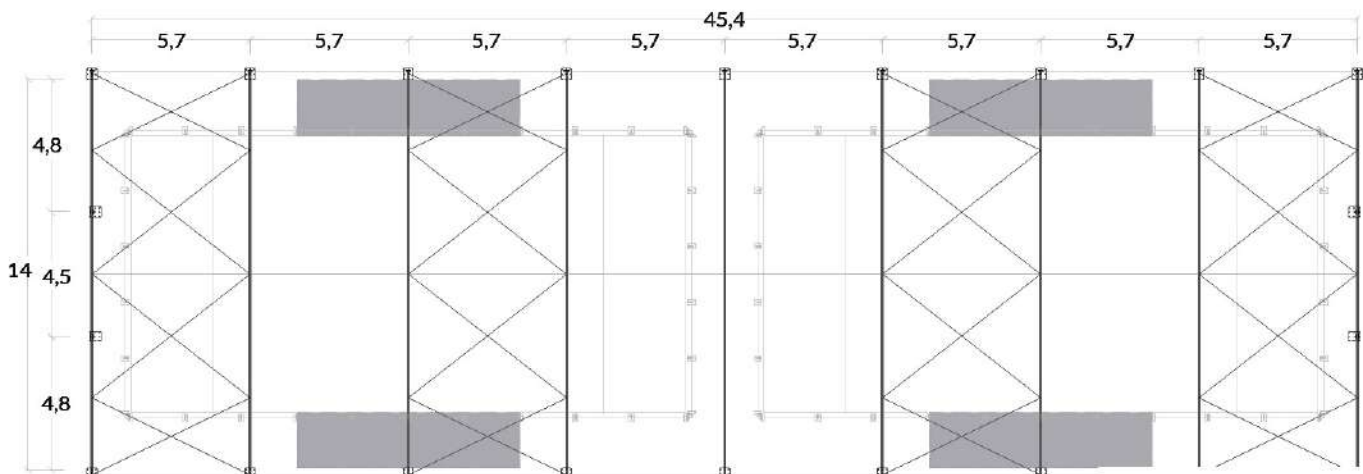



SINGLE PADEL BREAK 15

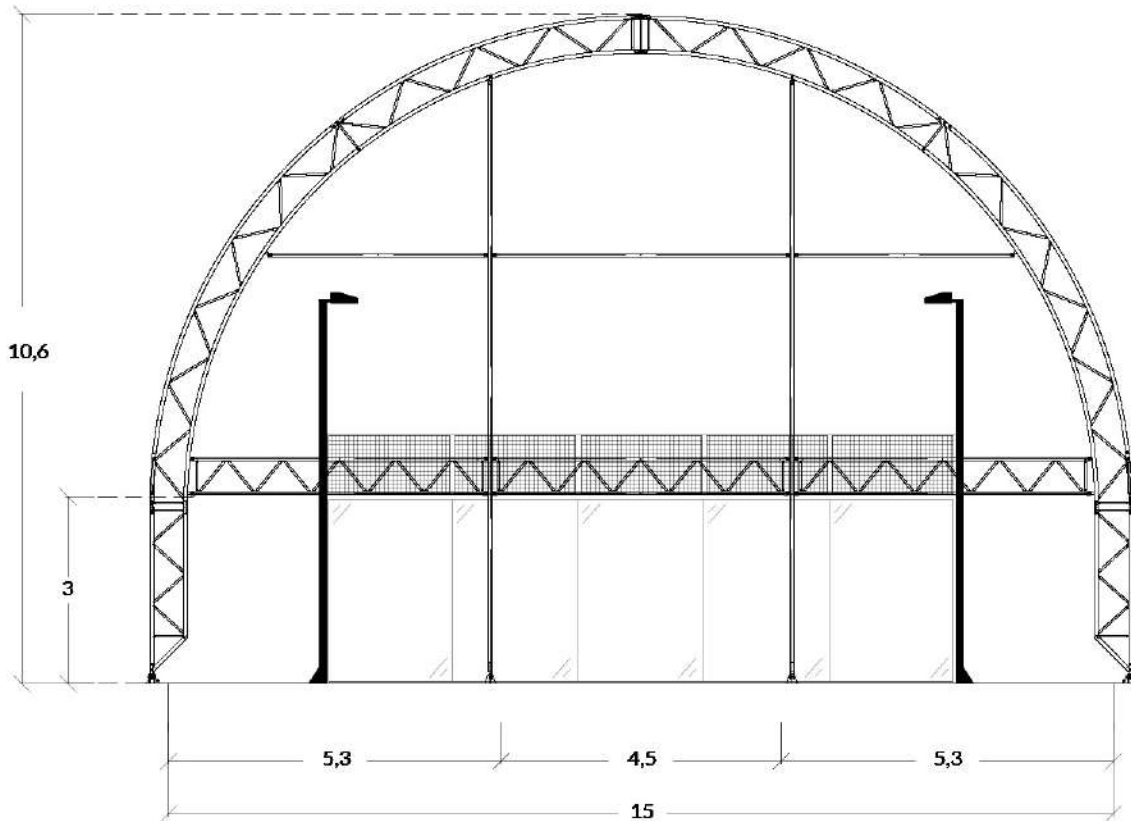

Courts number 1 / 2
Nombre de courts 1 / 2
Numero campi da gioco 1 / 2
Número de pistas 1 / 2



Fundations needed
Fondations nécessaires
Fondazioni necessarie
Cimentaciones necesarias



Medium snow loads
Charge de neige moyennes
Carico neve medio
Cargas de nieve media



Allows outside play
Permet le jeu extérieur
Permette il gioco all'esterno
Permite juego exterior

Side view | Vue latérale | Vista laterale | Vista Lateral

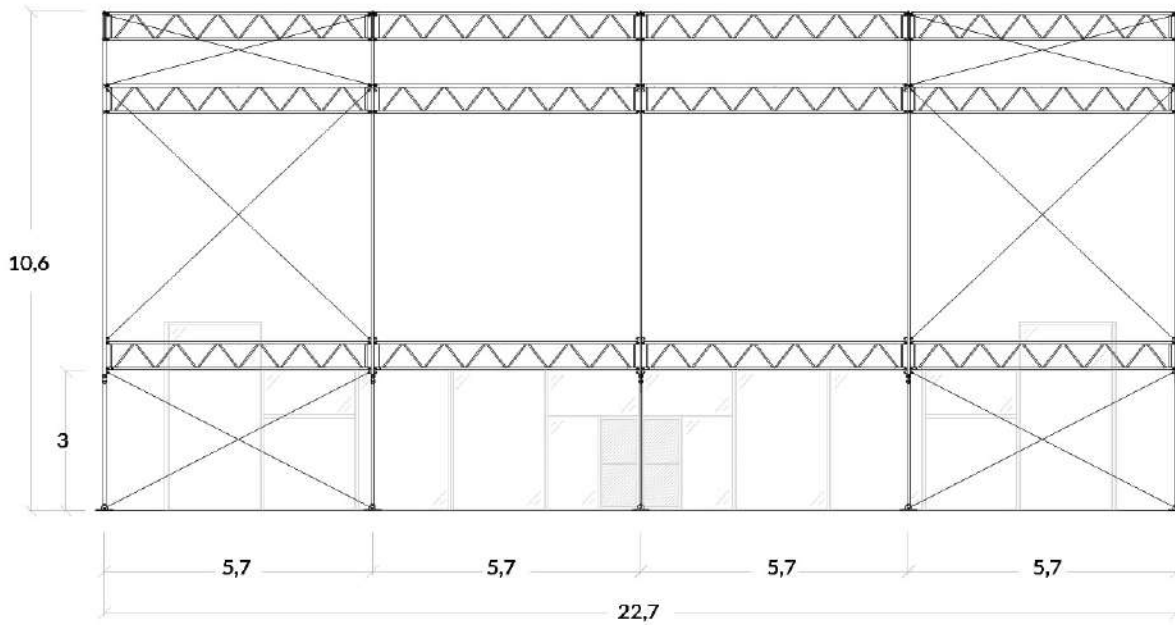

Top view | Vue plan | Pianta | Planta

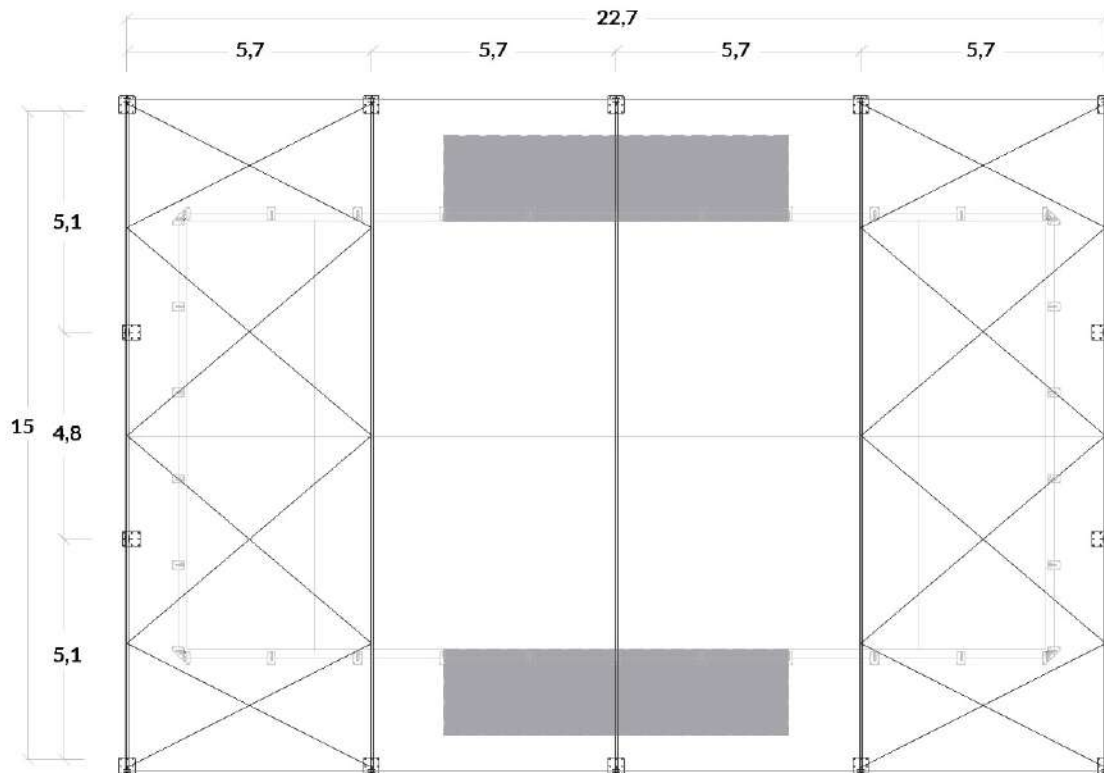

Top view double | Vue plan double | Doppia pianta | Planta doble

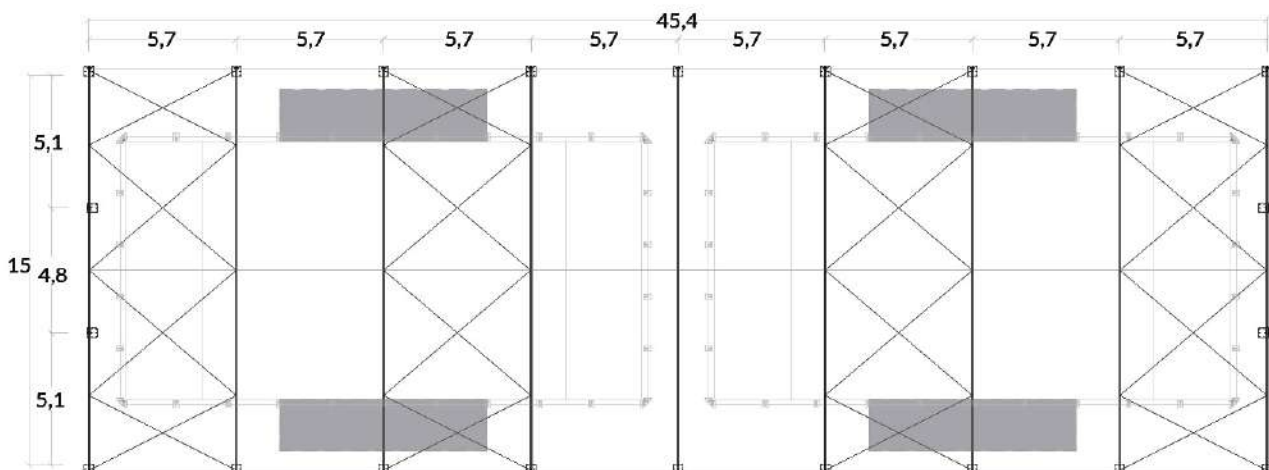



SINGLE PADEL LOB 4.16

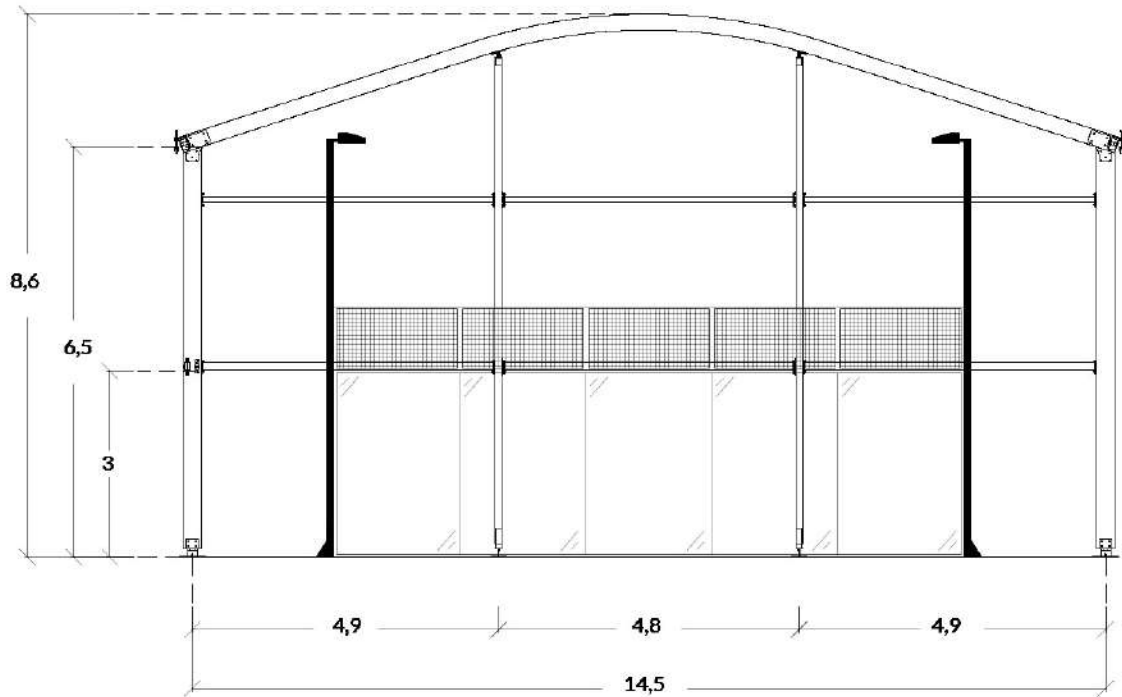

Courts number 1 / 2
Nombre de courts 1 / 2
Numero campi da gioco 1 / 2
Número de pistas 1 / 2



Fundations needed
Fondations nécessaires
Fondazioni necessarie
Cimentaciones necesarias



Very high snow loads
Charge de neige très élevée
Carico neve molto alto
Cargas de nieve muy alto



Allows outside play
Permet le jeu extérieur
Permette il gioco all'esterno
Permite juego exterior

Side view | Vue latérale | Vista laterale | Vista Lateral

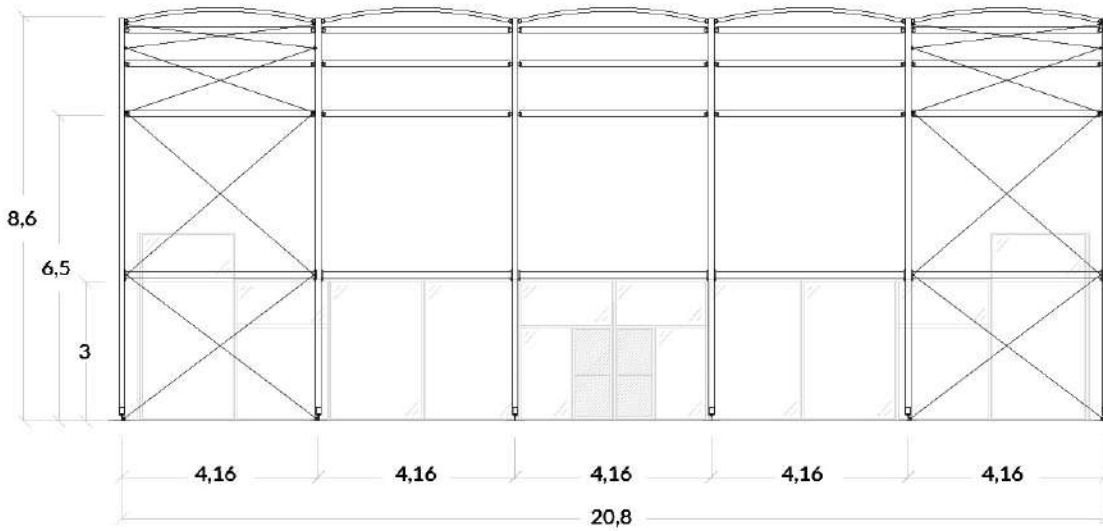

Top view | Vue plan | Pianta | Planta

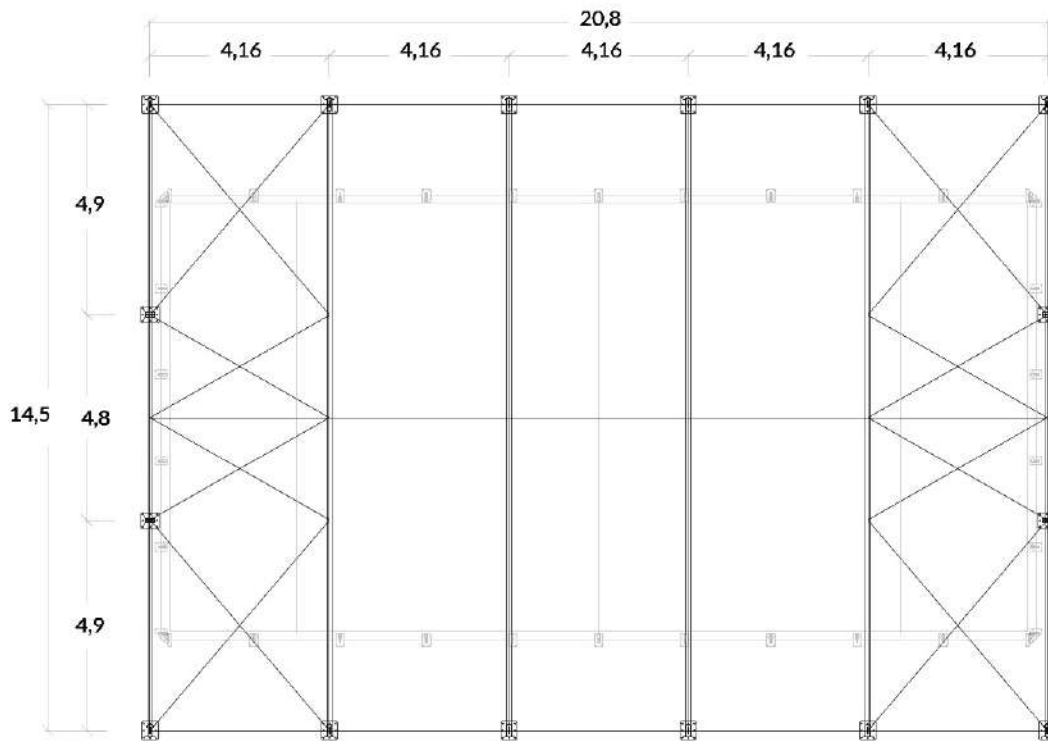

Top view double | Vue plan double | Doppia pianta | Planta doble

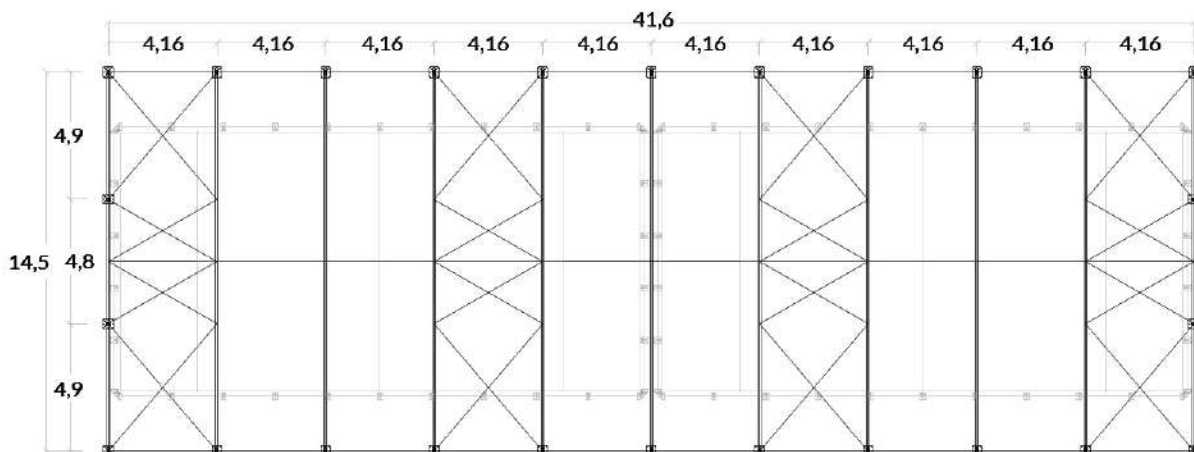



SINGLE PADEL LOB 5.2

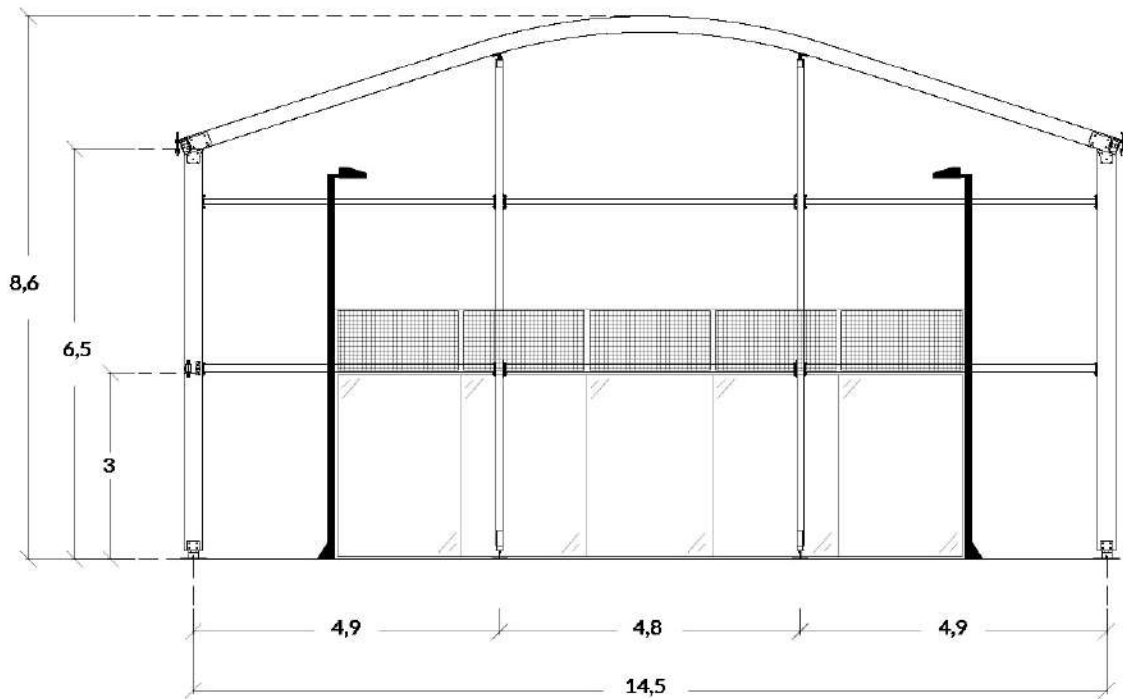

Courts number 1 / 2
Nombre de courts 1 / 2
Numero campi da gioco 1 / 2
Número de pistas 1 / 2



Fundations needed
Fondations nécessaires
Fondazioni necessarie
Cimentaciones necesarias



High snow loads
Charge de neige élevée
Carico neve alto
Cargas de nieve alto



Allows outside play
Permet le jeu extérieur
Permette il gioco all'esterno
Permite juego exterior

Side view | Vue latérale | Vista laterale | Vista Lateral

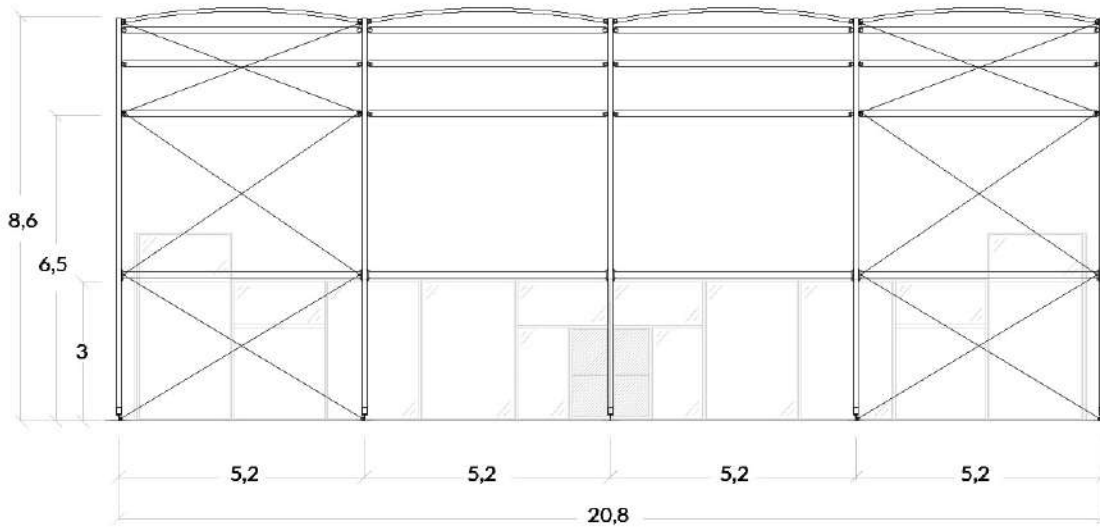

Top view | Vue plan | Pianta | Planta

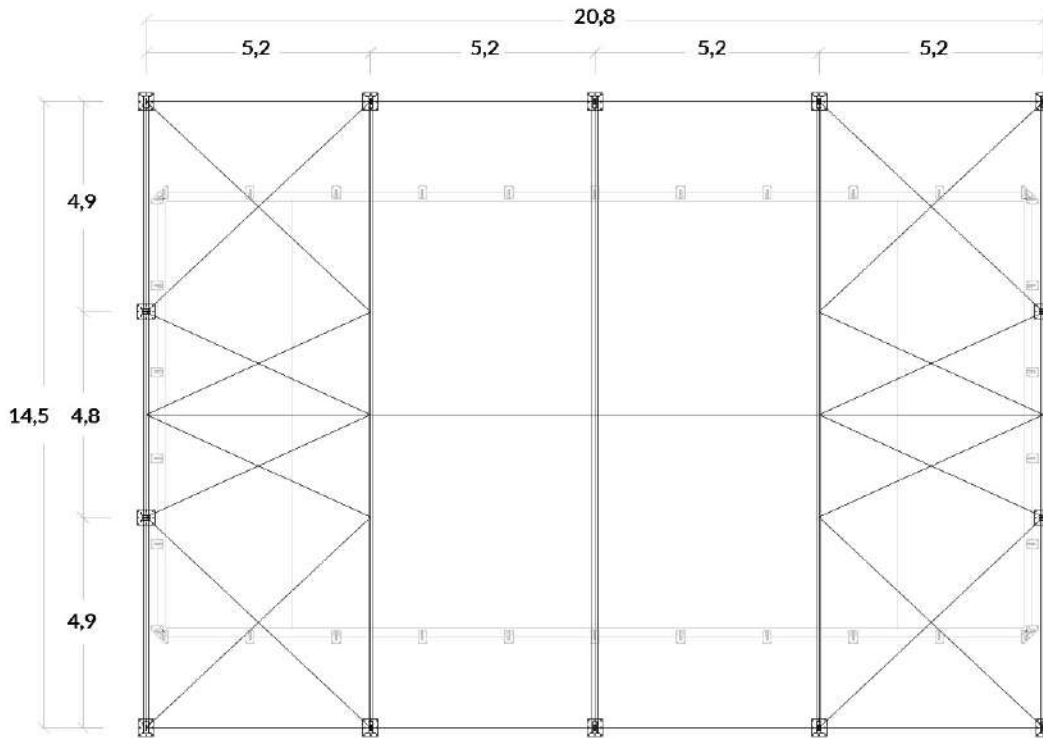

Top view double | Vue plan double | Doppia pianta | Planta doble

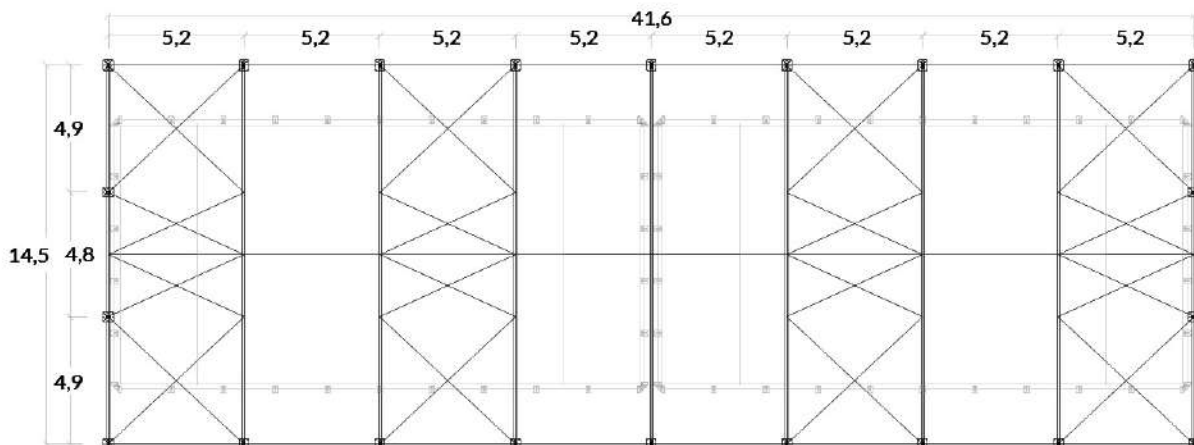



SINGLE PADEL LOB 6.9

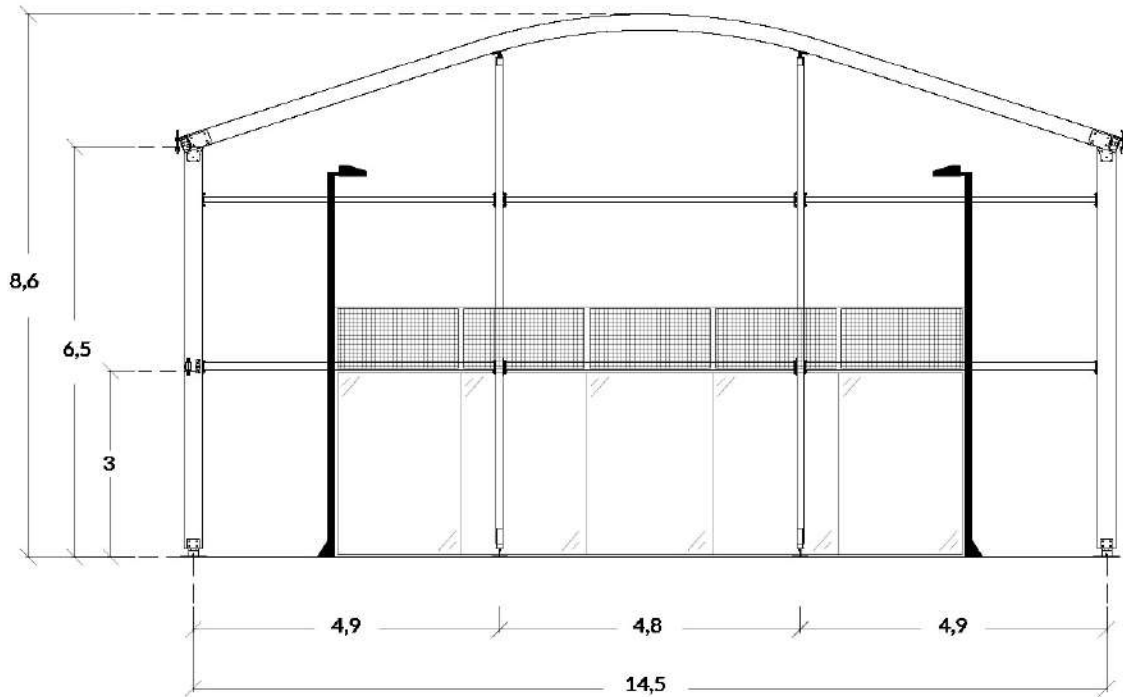

Courts number 1 / 2
Nombre de courts 1 / 2
Numero campi da gioco 1 / 2
Número de pistas 1 / 2



Fundations needed
Fondations nécessaires
Fondazioni necessarie
Cimentaciones necesarias



Medium snow loads
Charge de neige moyennes
Carico neve medio
Cargas de nieve media



Allows outside play
Permet le jeu extérieur
Permette il gioco all'esterno
Permite juego exterior

Side view | Vue latérale | Vista laterale | Vista Lateral

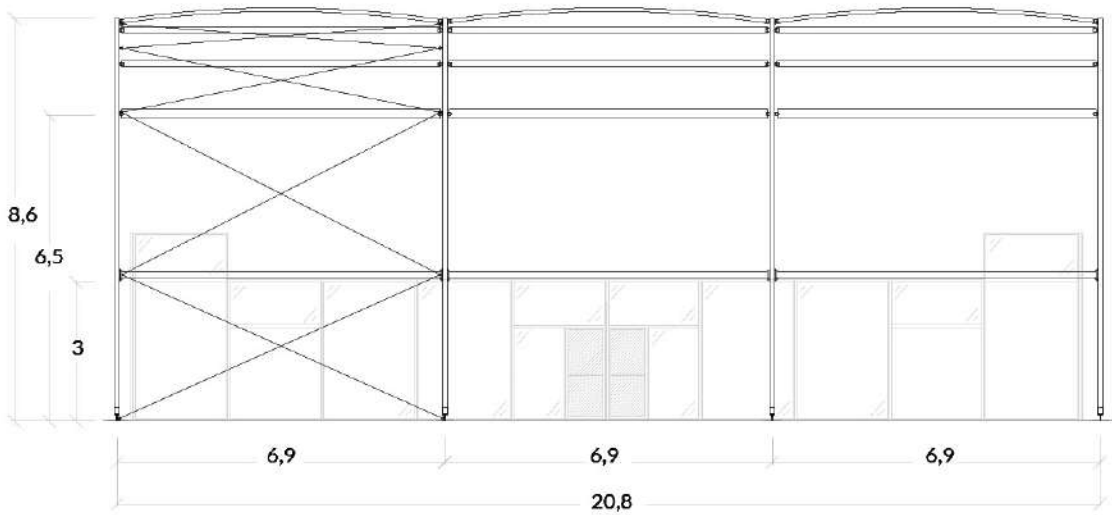

Top view | Vue plan | Pianta | Planta

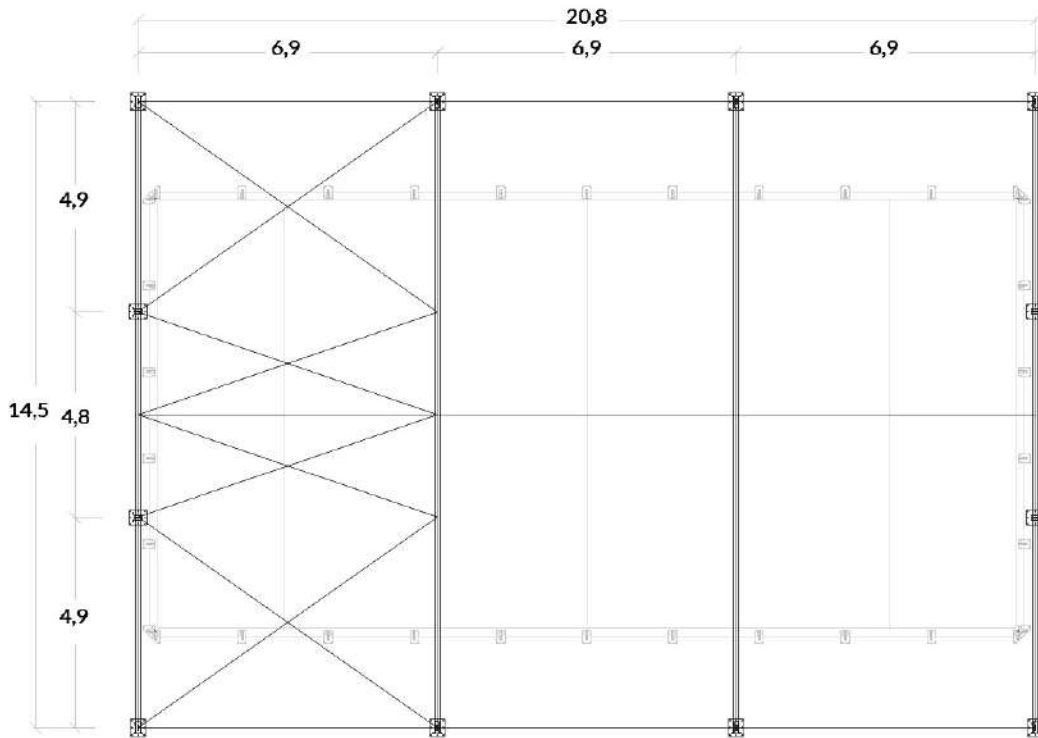

Top view double | Vue plan double | Doppia pianta | Planta doble

